

# Grandstream Networks, Inc.

---

DP750/DP720

DECT Cordless IP Phones

**User Guide**



## **COPYRIGHT**

©2018 Grandstream Networks, Inc. <http://www.grandstream.com>

All rights reserved. Information in this document is subject to change without notice. Reproduction or transmittal of the entire or any part, in any form or by any means, electronic or print, for any purpose without the express written permission of Grandstream Networks, Inc. is not permitted.

The latest electronic version of this user manual is available for download here:

<http://www.grandstream.com/support>

Grandstream is a registered trademark and Grandstream logo is trademark of Grandstream Networks, Inc. in the United States, Europe and other countries.

## **CAUTION**

Changes or modifications to this product not expressly approved by Grandstream, or operation of this product in any way other than as detailed by this User Manual, could void your manufacturer warranty.

## **WARNING**

Please do not use a different power adaptor with your devices as it may cause damage to the products and void the manufacturer warranty.



## GNU GPL INFORMATION

DP750 firmware contains third-party software licensed under the GNU General Public License (GPL). Grandstream uses software under the specific terms of the GPL. Please see the GNU General Public License (GPL) for the exact terms and conditions of the license.

Grandstream GNU GPL related source code can be downloaded from Grandstream web site from:  
<http://www.grandstream.com/support/faq/gnu-general-public-license/gnu-gpl-information-download>



# Table of Content

<b>DOCUMENT PURPOSE</b> .....	<b>9</b>
<b>CHANGE LOG</b> .....	<b>10</b>
Firmware Version 1.0.4.2.....	10
Firmware Version 1.0.3.40.....	10
Firmware Version 1.0.3.37.....	10
Firmware Version 1.0.3.31.....	10
Firmware Version 1.0.3.23.....	10
Firmware Version 1.0.2.16.....	10
Firmware Version 1.0.1.14.....	11
Firmware Version 1.0.1.4.....	11
Firmware Version 1.0.0.16.....	12
<b>GUI INTERFACE EXAMPLES</b> .....	<b>13</b>
<b>WELCOME</b> .....	<b>14</b>
<b>PRODUCT OVERVIEW</b> .....	<b>15</b>
Feature Highlights.....	15
DP750 Technical Specifications.....	15
DP720 Technical Specifications.....	17
<b>GETTING STARTED</b> .....	<b>19</b>
Equipment Packaging.....	19
Connecting DP750.....	20
<i>Connecting via AC power</i> .....	20
<i>Connecting via PoE</i> .....	20
Setting up DP720 handset.....	21
<i>Battery Information</i> .....	21
Setting up the Charge Station.....	22
DP750 LED Patterns.....	22
DP720 Handset Description.....	23



DP720 Icons Description .....	24
DP720 Handset Menu.....	26

## **BASIC OPERATIONS..... 29**

Turning the Handset ON / OFF .....	29
Setup Wizard .....	29
Register DP720 Handset to DP750 Base Station .....	29
Using DP720 with Multiple DP750 Base Stations .....	30
<i>Registering DP720 to an additional DP750 base station .....</i>	<i>30</i>
<i>Switching Between Different Base Stations .....</i>	<i>31</i>
Unregister the DP720 .....	32
Obtain DP750 Base Station IP Address via paired DP720.....	33
Setting the Key Lock.....	33
Locating a DP720 Handset from DP750 Base station.....	34
<i>Locate via DP750 Web UI .....</i>	<i>34</i>
<i>Locate via DP750 Base station .....</i>	<i>35</i>
Checking System Status.....	35
Basic Network Settings.....	35
Change Menu and LCD Timeout .....	36
Return to Idle Screen .....	37
Register a SIP Account.....	37
<i>Register Account via Web User Interface.....</i>	<i>37</i>

## **PHONE SETTINGS..... 40**

Editing the Handset's name.....	40
Changing the Base PIN Code.....	41
Selecting Phone Language.....	43
Activate/Deactivate Hands-Free Mode .....	43
Muting the Microphone .....	44
Adjusting Speaker and Earpiece Volume .....	44
Ringtones.....	44
<i>Setting the Ringer Volume on the Handset .....</i>	<i>44</i>



<i>Setting the Ringer Melody on the Handset</i> .....	45
<i>Advisory Tones</i> .....	46
<i>Ringtones Customization</i> .....	46
Date and Time.....	50
Outgoing Default Line .....	50
Factory Functions .....	51
DP720 Handset Firmware Upgrade.....	52
Reboot DP750 Base Station .....	52
Reset DP720 Handset .....	53
<b>CALL OPERATIONS .....</b>	<b>54</b>
Placing calls .....	54
<i>Make a Call using a Line</i> .....	54
<i>Dialing from Call history</i> .....	55
<i>Dialing from Phonebook</i> .....	55
Answering Calls .....	56
<i>Auto Answer</i> .....	56
<i>Off-Cradle Pickup</i> .....	57
Ending Calls.....	57
<i>On-Cradle Hang-up</i> .....	57
Rejecting Calls .....	58
Direct IP Call .....	58
Call Hold/Resume .....	59
Call Waiting .....	59
Do Not Disturb .....	60
Call Forward.....	60
Call Transfer.....	61
<i>Blind Transfer</i> .....	61
<i>Attended Transfer</i> .....	61
Speed Dial .....	61
3-Way Conference .....	62



Voice Mail.....	63
<i>Set Voice Mail Feature Code</i> .....	63
<i>Play Voice Mail Messages</i> .....	63
Call Features.....	64
<b>RESTORE FACTORY DEFAULT SETTINGS.....</b>	<b>65</b>
<b>EXPERIENCING DP750/DP720 .....</b>	<b>66</b>



## Table of Tables

Table 1: DP750 Features at a Glance .....	15
Table 2: DP720 Features at a Glance .....	15
Table 3: DP750 Technical Specifications .....	15
Table 4: DP720 Technical Specifications .....	17
Table 5: Equipment Packaging .....	19
Table 6: DP750 Led Patterns .....	22
Table 7: Handset Keys Description .....	23
Table 8: DP720 Icons Description .....	24
Table 9: DP720 Info description .....	35
Table 10: Call Features .....	64





## Table of Figures

Figure 1: DP750 Package Content .....	19
Figure 2: DP720 Package Content .....	19
Figure 3: DP750 Back View .....	20
Figure 4: Connecting the Base station .....	20
Figure 5: Setting up the DP720 .....	21
Figure 6: Setting up the charge station .....	22
Figure 7: Handset Keys Description .....	23
Figure 8: DP720 Menu Structure .....	26
Figure 9: DECT Status - Subscribe .....	29
Figure 10: Registration process .....	30
Figure 11: Multiple Base Stations Registration .....	31
Figure 12: Switching Between Base Stations .....	31
Figure 13: Unregister DP720 from DP750 web UI .....	32
Figure 14: Locate Handset via Web UI .....	34
Figure 15: Network Settings configuration .....	36
Figure 16: SIP Settings .....	38
Figure 17: SIP Accounts Settings .....	39
Figure 18: Account Status .....	39
Figure 19: Handset Name editing .....	40
Figure 20: Edit Handset Name from DP750 .....	41
Figure 21: Changing Admin Base PIN Code from DP720 .....	42
Figure 22: Changing Admin Base PIN Code from DP750 .....	42
Figure 23: Handset Language .....	43
Figure 24: Ringer Volume .....	45
Figure 25: Calls Ringtones .....	45
Figure 26: Advisory Tone .....	46
Figure 27: Generating Custom Ringtone (Windows) .....	47
Figure 28: Downloading Custom Ringtones .....	48
Figure 29: Custom Ringtone on DP750 .....	49
Figure 30: Custom Ringtone on DP720 .....	49
Figure 31: Date and Time Settings .....	50
Figure 32: Factory Functions .....	51
Figure 33: New Firmware Available Notification .....	52
Figure 34: Firmware Upgrade .....	52
Figure 35: Rebooting the Base Station .....	53
Figure 36: Resetting the Base Station .....	53



## DOCUMENT PURPOSE

This document describes the basic concept and tasks necessary to use and configure your DP720 via the LCD menu and also using the DP750 base station. And it covers the handset installation, basic operations and call features. Please visit <http://www.grandstream.com/support> to download the latest “DP750/DP720 User Guide”.

This guide covers following topics:

- [Product Overview](#)
- [Getting Started](#)
- [Basic Operations](#)
- [Phone settings](#)
- [Call Operations](#)
- [Restore Factory Default Settings](#)



## CHANGE LOG

This section documents significant changes from previous versions of user guide for DP750/DP720. Only major new features or major document updates are listed here. Minor updates for corrections or editing are not documented here.

### Firmware Version 1.0.4.2

- Added support for DP720 to use Audio Loopback test when it is not registered to the base station. [Audio Loopback] [Audio loopback]
- Play keypad tone during the call if it is enabled. [Advisory Tones]

### Firmware Version 1.0.3.40

- Increased the number of digits that can be dialed on the handset (23 digits).

### Firmware Version 1.0.3.37

- No major changes

### Firmware Version 1.0.3.31

- Added language support for Slovakian, Swedish. [Multi-language]

### Firmware Version 1.0.3.23

- Removed Tools/alarm menu from DP720 GUI, replaced by Status menu. [Status]
- Added keypad tones for non DTMF keys on DP720.
- Added subscribe softkey in idle screen if HS no subscribed on DP720. [Subscribe softkey]
- Added the ability to customize DP720 ringtones. [Ringtones Customization]
- Added DP720 walk through setup wizard after factory reset. [Setup Wizard]
- Added support for more languages and updated translation.
- Added DP720 factory reset combo key to be able to recover the device during booting up. [DP720 factory reset using combo key]

### Firmware Version 1.0.2.16

- Re-arranged the Handset Menu Settings. [DP720 Handset Menu]
- Changed menu “Line Status” in Call Settings to “Lines”. [Lines]
- Changed menu “Number” in set voice Mail to “VM Access Number”.
- Added headset detection and icon for DP720 dial mode screen. [DP720 Icons Description]
- Added ability to bridge conference before third party answers. [3-Way Conference]



- Added ability to reboot from DP720 handset. [Reboot DP750 Base Station]
- Improved alarm snooze icon.
- Added DP720 LCD auto turn on feature when pickup from or reposition to charger.
- Added + button support for keypad dialing. [DP720 Handset Description] [Make a Call using a Line]
- Improved support for Czech, Dutch, German, Hebrew, Japanese, Korean, Turkish languages

## **Firmware Version 1.0.1.14**

- Added snooze time settings for alarm function.
- Added snooze icon.
- Updated alarm icon.
- Removed IVR (Interactive Voice Response).
- Added contact name to delete confirmation.
- Added use Line from Contacts when dialing out of phonebook. [Dialing from Phonebook]
- Added VM, missed calls, headset icon. [DP720 Icons Description]
- Removed “Intercom” feature.
- Removed “Internal Call” from audio ring tone menu.
- Adjusted Call History and Contacts menu architecture. [DP720 Handset Menu]
- Moved "Edit Dial" option to last one in Call History and Contacts menu option. [Dialing from Call history] [Dialing from Phonebook]
- Hide empty fields when displaying contact info.
- Hide icon after press back key in idle misses call or VM alert screen.
- Moved “Standard ring” to last one of ring tone list. [Ringtones]
- Missed Call can be dialed back via related SIP profile using softkey. [Dialing from Call history]

## **Firmware Version 1.0.1.4**

- Added Call and Delete softkeys during off-hook dial. [Placing calls]
- Added left softkey for Voice mail alert window to enter the Play Message window. [Play Voice Mail Messages]
- Added Display line name info immediately after off-hook. [Placing calls]
- Changed to only press ESC key to show factory menu.
- Added Dial number immediately after off-hook.
- Added Dialing GUI enhancements.
- Added ability to configure menu key timeout. [Change Menu and LCD Timeout]
- Added Handset will prompt “Saved successfully” if configuring call forward settings in ring group.
- Added advisory tone for handset put in and out of cradle.
- Added ability to configure menu key timeout.
- Added when last name is none use the first name for speed dial record name.
- Added when handset enter IVR, press RSK hold key will delete dial number.
- Added stop dial tone if first key not number key after off hook



## **Firmware Version 1.0.0.16**

- This is the initial version for DP750/DP720.



## GUI INTERFACE EXAMPLES

[http://www.grandstream.com/sites/default/files/Resources/dp750\\_web\\_gui.zip](http://www.grandstream.com/sites/default/files/Resources/dp750_web_gui.zip)

1. Screenshot of Login Page
2. Screenshots of Status Pages
3. Screenshots of Profiles Pages
4. Screenshots of DECT Pages
5. Screenshots of Settings Pages
6. Screenshots of Maintenance Pages
7. Screenshots of Phonebook Pages



## WELCOME

Thank you for purchasing Grandstream DP750 DECT IP Base Station and DP720 DECT Handset.

The DP750 is a powerful DECT VoIP base station that pairs with up to 5 of Grandstream's DP720 DECT handsets to offer mobility to business and residential users. It supports a range of 300 meters outdoors and 50 meters indoors to give users the freedom to move around their work or home space, delivering efficient flexibility. This DECT VoIP base station supports up to 10 SIP accounts and 5 concurrent calls while also offering 3-way voice conferencing, full HD audio and integrated PoE. A shared SIP account on all handsets will add seamless unified features that gives users the ability to answer all calls regardless of location in real-time. The DP750 supports a variety of auto-provisioning methods and TLS/SRTP/HTTPS encryption security. When paired with Grandstream's DP720, the DP750 offers a powerful DECT VoIP base station that allows any business or residential user to create a cordless VoIP solution.

The DP720 is a DECT cordless VoIP phone that allows users to mobilize their VoIP network throughout any business, warehouse, retail store and residential environment. It is supported by Grandstream's DP750 DECT VoIP base station and delivers a combination of mobility and top-notch telephony performance. Up to five DP720 handsets are supported on each DP750 while each DP720 supports a range of up to 300 meters outdoors and 50 meters indoors from the base station. The DP720 touts a suite of top-notch telephony features including support for up to 10 SIP accounts per handset, full HD audio, a 3.5mm headset jack, multi-language support, a speakerphone and more. When paired with Grandstream's DP750 DECT Base Station, the DP720 offers a powerful DECT VoIP handset that allows any business or residential user to create a cordless VoIP solution.



## PRODUCT OVERVIEW

### Feature Highlights

The following tables contain the major features of the DP750 / DP720:

**Table 1: DP750 Features at a Glance**

 <p><b>DP750</b></p>	<ul style="list-style-type: none"> <li>• 5 handsets.</li> <li>• 10 accounts.</li> <li>• 10 lines.</li> <li>• 5 concurrent calls.</li> <li>• PoE power support.</li> <li>• 300m range outdoor / 50m range indoor.</li> </ul>
---	---

**Table 2: DP720 Features at a Glance**

 <p><b>DP720</b></p>	<ul style="list-style-type: none"> <li>• DECT cordless HD.</li> <li>• 1.8 inch (128x160) TFT color LCD.</li> <li>• 250 hours standby / 20 hours talk time.</li> <li>• 15 languages embedded.</li> <li>• 10 accounts.</li> <li>• 10 lines.</li> <li>• 5 ring modes.</li> </ul>
---	---

### DP750 Technical Specifications

The following table resumes all the technical specifications including the protocols / standards supported, voice codecs, telephony features, languages and upgrade/provisioning settings for the Base station DP750.

**Table 3: DP750 Technical Specifications**

<b>Air Interface</b>	<p><b>Telephony standards:</b> DECT</p> <p><b>Frequency bands:</b></p> <ul style="list-style-type: none"> <li>▪ 1880 – 1900 MHz (Europe), 1920 – 1930 MHz (US)</li> <li>▪ 1910 – 1920 MHz (Brazil), 1786 – 1792 MHz (Korea)</li> <li>▪ 1893 – 1906 MHz (Japan), 1880 – 1895 MHz (Taiwan)</li> </ul> <p><b>Number of channels:</b> 10 (Europe), 5 (US, Brazil or Japan), 3 (Korea), 8 (Taiwan)</p> <p><b>Range:</b> up to 300 meters outdoor and 50 meters indoor</p>
----------------------	--



<b>Peripherals</b>	5 LED indicators: Power, Network, Register, Call, DECT Reset button, Pairing/Paging button One 10/100 Mbps auto-sensing Ethernet port with integrated PoE
<b>Protocols/Standards</b>	SIP RFC3261, TCP/IP/UDP, RTP/RTCP, HTTP/HTTPS, ARP/RARP, ICMP, DNS (A record, SRV, NAPTR), DHCP, PPPoE, SSH, TFTP, NTP, STUN, SIMPLE, LLDP-MED, LDAP, TR-069, 802.1x, TLS, SRTP, IPv6 (pending)
<b>Voice Codecs</b>	G.711 $\mu$ /a-law, G.723.1, G.729A/B, G.726-32, iLBC, G.722, OPUS, G.722.2/AMR-WB (special order), in-band and out-of-band DTMF (in audio, RFC2833, SIP INFO), VAD, CNG, PLC, AJB
<b>Telephony Features</b>	Hold, transfer, forward, 3-way conference, downloadable phonebook (XML, LDAP, up to 3000 entries), call waiting, call log (up to 300 records), auto answer, flexible dial plan, music on hold, server redundancy and fail-over
<b>Sample Applications</b>	Currency (pending)
<b>QoS</b>	Layer 2 QoS (802.1Q, 802.1p) and Layer 3 QoS (ToS, DiffServ, MPLS)
<b>Security</b>	User and administrator level access control, MD5 and MD5-sess based authentication, 256-bit AES encrypted configuration file, TLS, SRTP, HTTPS, 802.1x media access control, DECT authentication & encryption
<b>Multi-language</b>	English, Czech, German, Spanish, French, Arabic, Hebrew, Italian, Russian, Netherlands, Japanese, Polish, Chinese Simple, Chinese Tradition, Korean, Portuguese, Slovakian, Serbian, Swedish and Turkish.
<b>Upgrade/ Provisioning</b>	Firmware upgrade via TFTP/HTTP/HTTPS, mass provisioning using TR-069 or AES encrypted XML configuration file
<b>Multiple SIP Accounts</b>	Up to ten (10) distinct SIP accounts per system <b>Each handset</b> may map to any SIP account(s) <b>Each SIP account</b> may map to any handset(s)
<b>Ring Group</b>	Flexible options when multiple handsets share the same SIP account <ul style="list-style-type: none"> <li>▪ <b>Circular Mode:</b> all phones ring sequentially, starting with the phone after the one which rang last.</li> <li>▪ <b>Linear Mode:</b> all phones ring sequentially in the predetermined order, starting with the first phone each time.</li> <li>▪ <b>Parallel Mode:</b> all phones ring concurrently; after one phone answers, the remaining available phones can make new calls</li> </ul>
<b>Power &amp; Green Energy Efficiency</b>	Universal Power Supply Input AC 100-240V 50/60Hz; Output 5VDC, 1A; Micro-USB connection; PoE: IEEE802.3af Class 1, 0.44W–3.84W
<b>Package Content</b>	Base unit, Universal Power Supply, Ethernet cable, Quick Installation Guide, GPL Statement
<b>Dimensions</b>	28.5 mm (H) x 130 mm (W) x 90 mm (D)
<b>Weight</b>	Base unit: 143g, Universal Power Supply: 50g; Package: 360g
<b>Temperature</b>	Operation: -10° to 55°C (14 to 131°F); Storage: -20° to 60°C (-4 to 140°F);



<b>and Humidity</b>	Humidity: 10% to 90% non-condensing
<b>Compliance</b>	FCC: Part 15D, 47 CFR 2.1093, Part 15B CE: EN60950; EN301489-1-6; EN301406 RCM: AS/NZS60950 ANATEL: #2288-16-9452

## DP720 Technical Specifications

The following table resumes all the technical specifications including the protocols / standards supported, voice codecs, telephony features, languages and upgrade/provisioning settings for the DP720 handset.

**Table 4: DP720 Technical Specifications**

<b>Air Interface</b>	<b>Telephony standards:</b> DECT <b>Frequency bands:</b> <ul style="list-style-type: none"> <li>▪ 1880 – 1900 MHz (Europe), 1920 – 1930 MHz (US)</li> <li>▪ 1910 – 1920 MHz (Brazil), 1786 – 1792 MHz (Korea)</li> <li>▪ 1893 – 1906 MHz (Japan), 1880 – 1895 MHz (Taiwan)</li> </ul> <b>Number of channels:</b> 10 (Europe), 5 (US, Brazil or Japan), 3 (Korea), 8 (Taiwan) <b>Range:</b> up to 300 meters outdoor and 50 meters indoor
<b>Peripherals</b>	1.8 inch (128x160) color TFT LCD 23 keys including 2 softkeys, 5 navigation / menu keys, 4 dedicated function keys for SEND, POWER/END, SPEAKERPHONE, MUTE 3-color MWI LED 3.5mm headset jack Removable belt clip Micro-USB port for alternative charging and non-battery operation
<b>Protocols/Standards</b>	Hearing Aid Compatibility (HAC) compliant
<b>Voice Codecs</b>	G.722 codec for HD audio and G.726 codec for narrow band audio (G.711 $\mu$ /a-law, G.723.1, G.729A/B, iLBC and OPUS are supported via companion DECT base station DP750), AEC, AGC, Ambient noise reduction
<b>Telephony Features</b>	Hold, transfer, forward, 3-way conference, call park, call pickup, downloadable phonebook, call waiting, call log, auto answer, click-to-dial, flexible dial plan, music on hold
<b>Sample Applications</b>	Currency (pending)
<b>HD Audio</b>	Yes, in both Handset and Speakerphone modes
<b>Security</b>	DECT authentication & encryption
<b>Multi-language</b>	English, Czech, German, Spanish, French, Hebrew, Italian, Netherlands, Japanese, Chinese, Chinese simple, Polish, Russian, Chinese Simple, Chinese Tradition, Korean, Portuguese, Slovakian, Serbian, Swedish, Turkish and Arabic.



<b>Upgrade/ Provisioning</b>	Software Upgrade Over-The-Air (SUOTA), handset provisioning Over-The-Air
<b>Multiple Line Access</b>	Each handset may access up to 10 lines
<b>Power &amp; Green Energy Efficiency</b>	Universal Power Supply Input AC 100-240V 50/60Hz; Output 5VDC 1A; Micro-USB connection; Rechargeable 800mAh Ni-MH Low Self-Discharge (LSD) AAA batteries (250 hours of standby time and 20 hours of talk time)
<b>Package Content</b>	Handset unit, universal power supply, charger cradle, belt clip, 2 batteries, Quick Installation Guide
<b>Dimensions (H x W x D)</b>	Handset: 155 x 50 x 26 mm, charger cradle: 35 x 63.5 x 54 mm
<b>Weight</b>	Handset: 138g, charger cradle: 71g, universal power supply: 50g; Package: 360g
<b>Temperature and Humidity</b>	Operation: -10° to 50°C (14 to 122°F); Charging: 0 to 45°C (32 to 113°F); Storage: -20° to 60°C (-4 to 140°F); Humidity: 10% to 90% non-condensing
<b>Compliance</b>	FCC: Part 15D; 47 CFR 2.1093 & IEEE1528-2013, Part68, Part 15B CE: EN60950; EN301489-1-6; EN301406; EN50360; EN62209-1 RCM: AS/NZS60950; AS/ACIF S004 ANATEL: #2288-16-9452



## GETTING STARTED

This chapter provides basic installation instructions including the list of the packaging contents and also information for obtaining the best performance with the DP720 IP DECT phone and its base station DP750.

### Equipment Packaging

Table 5: Equipment Packaging

DP720	DP750
<ul style="list-style-type: none"> <li>• 1 Handset unit</li> <li>• 1 Universal power supply 5V</li> <li>• 1 Charger cradle</li> <li>• 1 Belt clip</li> <li>• 2 Rechargeable batteries</li> <li>• 1 Quick Installation Guide</li> </ul>	<ul style="list-style-type: none"> <li>• 1 Base unit</li> <li>• 1 Universal power supply 5V</li> <li>• 1 Ethernet cable</li> <li>• 1 Quick Installation Guide</li> <li>• 1 GPL Statement</li> </ul>

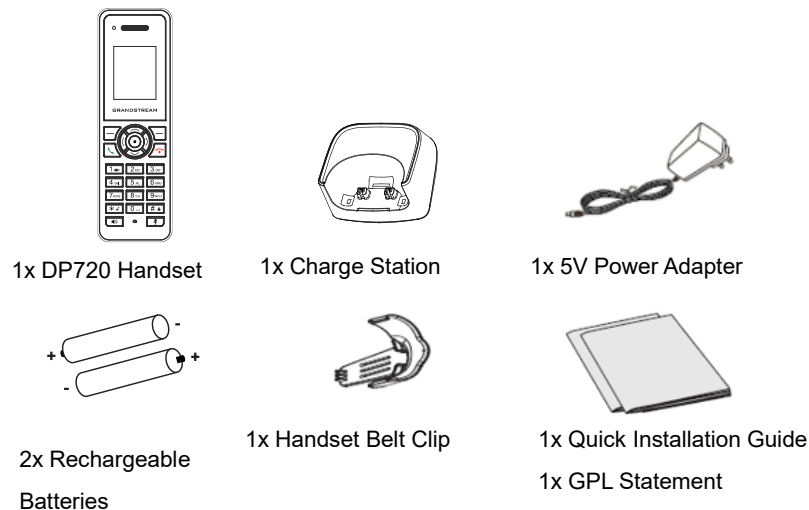
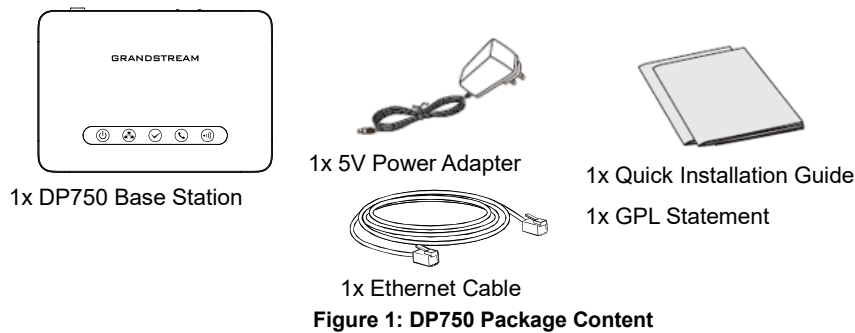

**Note:** Check the package before installation. If you find anything missing, contact your system administrator.

## Connecting DP750

To setup the DP750 Base Station, please follow the steps below:

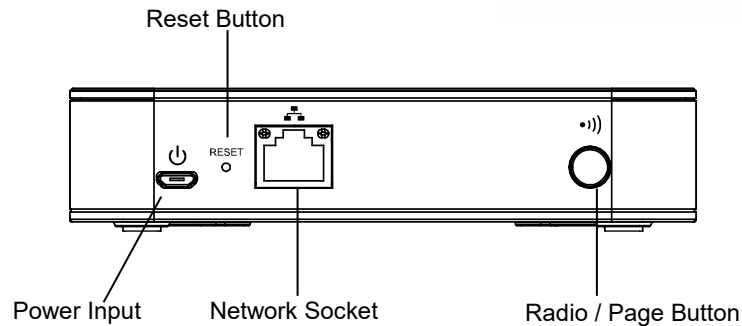

**Figure 3: DP750 Back View**

You have two options for power and network connection of the base station: AC power or Power over Ethernet (PoE)

**Note:** For better signal range, we recommend to install DP750 horizontally with LED side facing toward the usage area. For example, if you just put it on a desk, the LED better face up, if you mount it on the ceiling, it better LED face down, in both cases, it toward the space area.

### Connecting via AC power

1. Connect the micro-USB connector into the related port on the base station and connect the other end of the power adapter into an electrical power outlet.
2. Connect the supplied Ethernet cable between the Internet port on the base station and the Internet port in your network or the switch/hub device port.

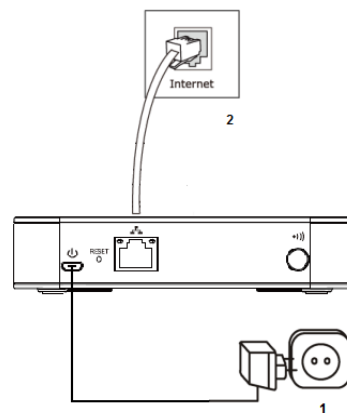

**Figure 4: Connecting the Base station**

### Connecting via PoE

To connect the base station using PoE, you need to connect the Ethernet cable provided (or 3rd party network cable) between the Network Socket on the base station to Ethernet port of your PoE switch/hub.

## Setting up DP720 handset

Please follow below steps to insert batteries into the handset:

1. Open the battery compartment cover.
2. Insert the batteries in the correct polarity.
3. Close the battery compartment cover.

**Note:** Please charge the batteries fully before using the handset for the first time

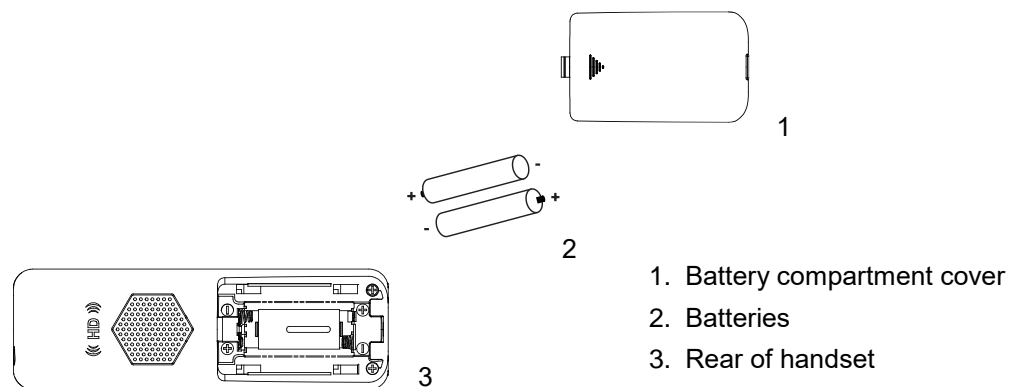

Figure 5: Setting up the DP

## Battery Information

- **Technology:** Nickel Metal Hydride (Ni-MH)
- **Size:** AAA
- **Voltage:** 1.2V
- **Capacity:** 800mAh
- **Charging time:** 12 hours from empty to full
- **Standby time:** up to 250 hours
- **Talk time:** up to 20 hours' active talk time

In order to get the best performance of your DP720 handset, we recommend using original batteries provided in the package or batteries compliant with above specifications.

The specifications may differ depending on the age and capacity of the batteries used.

**Important Note:** Be careful when inserting the batteries into your handset to avoid any risk of short-circuit, which lead to damage your batteries and/or the handset itself. Do not use damaged batteries which can increase the risk of serious harm.

## Setting up the Charge Station

Please refer to the following steps for setting up the charge station and charging the handset:

1. Connect the DC plug on the power adapter to the micro-USB connector on the charge station.
2. Connect the other end of the power adapter into an electrical power outlet.
3. After setting up the handset and the charge station, place the handset in the charge station.

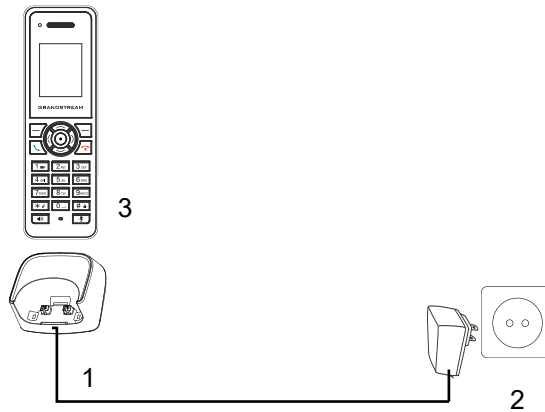







Figure 6: Setting up the charge station

## DP750 LED Patterns

The DP750 has 5 LED lights on it. Please see on the following table the meaning of each light.

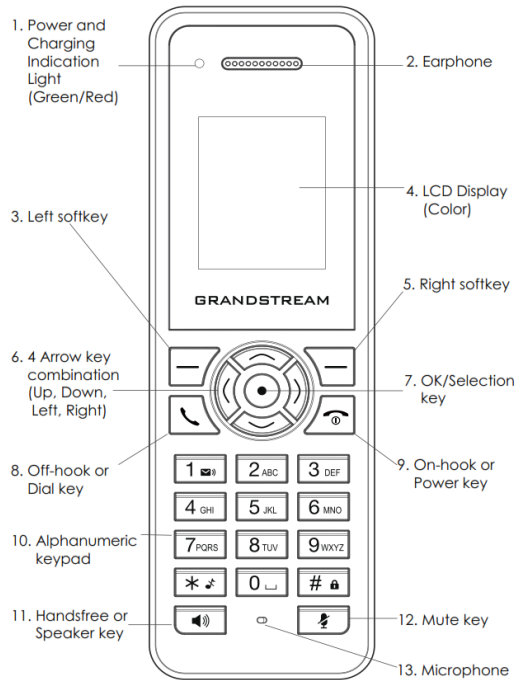

Table 6: DP750 Led Patterns

LED Light	Status
	Indicates power ON/OFF
	Indicates access to the Network. Remains ON while there is Access to the Network
	Indicates if a SIP account is registered
	Indicates status of the lines. <b>Blinking:</b> A line is in use. <b>Solid ON:</b> All lines are free.
	The radio icon for pairing the DP720 and DP750, if we keep pressing the radio button it starts blinking indicating pairing attempt.

## DP720 Handset Description

The LCD screen and the keypad are the main hardware components of the DP720.



**Figure 7: Handset Keys Description**

**Table 7: Handset Keys Description**















	Key	Description
1.	<b>Power and Charging Indication Light</b>	<b>Red:</b> Charging. <b>Green:</b> Charge completed. <b>Blinking:</b> Missed call(s) or Voice Mail received.
2.	<b>Earphone</b>	Delivers audio output.
3,5	<b>Left and right softkeys</b>	Correspond to functions displayed on the LCD. These functions change depending on the current context.
4.	<b>LCD display</b>	Shows call information, handset status icons, prompt messages, etc.
6.	<b>4 Arrow key combination</b>	Permits navigation of the cursor through the displayed menu options.
7.	<b>OK/Selection key</b>	Selects the option chosen by the cursor. (Enters the main menu from the home screen.)
8.	<b>Off-hook / Dial key</b>	Enters dialing mode, or dials number entered.
9.	<b>On-hook / Power key</b>	Terminates calls, or turns the handset on / off.
10.	<b>Alphanumeric Keypad</b>	Provides the digits, letters, and special characters in context-sensitive applications. For + sign, press and hold key 0.
11.	<b>Hands-free / Speaker key</b>	Switches between handset and hands-free / speaker modes.
12.	<b>Mute key</b>	Activates or deactivates the mute feature.
13.	<b>Microphone</b>	Picks up audio earpiece and hands-free calls.



















## DP720 Icons Description

The following table contains description of each icon that might be displayed on the screen of your DP720.

**Table 8: DP720 Icons Description**

	<b>Battery status</b> Not equipped with battery
	<b>Battery status</b> Battery empty
	<b>Battery status</b> Battery low
	<b>Battery status</b> Battery normal
	<b>Battery status</b> Battery full
	<b>Battery status</b> Charging
	<b>Signal status</b> Not subscribed
	<b>Signal status</b> Not in range
	<b>Signal status</b> Signal very low
	<b>Signal status</b> Signal low
	<b>Signal status</b> Signal normal
	<b>Signal status</b> Signal good
	<b>Signal status</b> Signal very good
	<b>Microphone MUTE Status</b> OFF - Not muted / ON – Muted
	<b>Speaker status</b> OFF - Speaker is inactivated ON - Speaker is activated

	<b>Headset icon</b>
	<b>Missed Call icon</b>
	<b>Voicemail icon</b>
	<b>Ringtone status</b> OFF - Ringtone off (Silent mode) ON - Ringtone on
	<b>Keypad Lock status</b> OFF - Keypad unlock ON - Keypad locked
	<b>Incoming Call notification</b>
	<b>Outgoing Call notification</b>
	<b>Missed Call notification</b>
	<b>Incoming Call notification</b>
	<b>Outgoing Call notification</b>
	<b>Voicemail notification</b>
	<b>Contacts</b>
	<b>Call History</b>
	<b>Voice Mail</b>
	<b>Settings</b>
	<b>Call Settings</b>
	<b>Status</b>

## DP720 Handset Menu

The handset has an easy-to-use menu structure. Every menu opens a list of options. To open the main menu, press “Menu” (left softkey) when the handset is on and in standby mode. Press Arrow keys to navigate to the menu option you require. Then press “Select” (left softkey) or **OK/Selection key** to access further options or confirm the setting displayed. To go to the previous menu item, press “Back” (right softkey). You can press **Power** key at any time to cancel and return to standby mode. If you do not press any key, the handset automatically reverts to standby mode after 20 seconds.

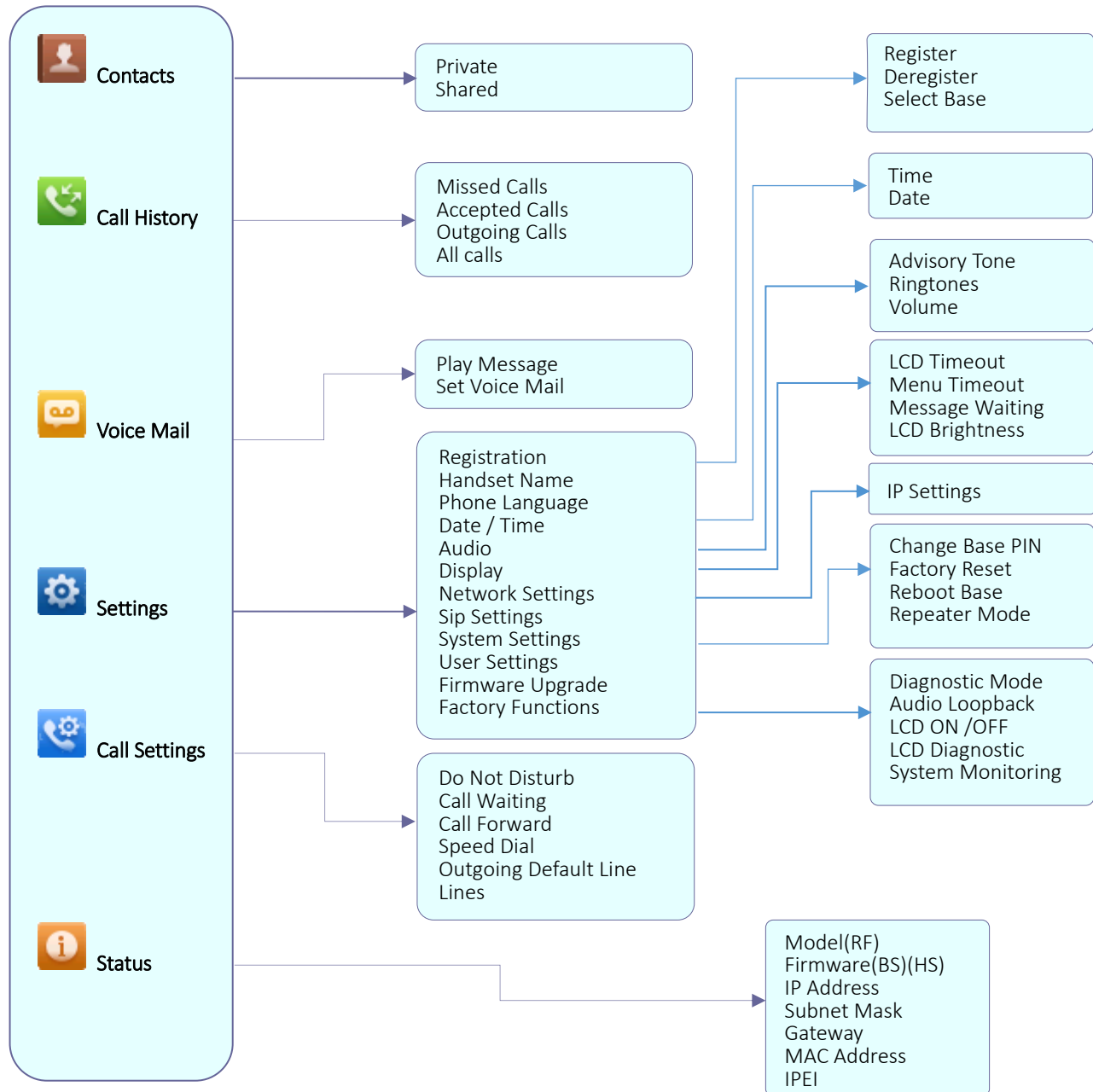

Figure 8: DP720 Menu Structure

<b>Contacts</b>	<ul style="list-style-type: none"> <li>• <b>Private:</b> Private contacts include contacts visible in the current handset only. You can add, edit, delete, and call all the entries in private contacts.</li> <li>• <b>Shared:</b> Shared contacts are the contacts shared between the handsets subscribed to the DP750 base station. You can add, edit, delete, edit and call all the entries in shared contacts as well.</li> </ul>
<b>Call History</b>	<p>Display the call history: <b>Missed Calls</b>, <b>Accepted Calls</b>, <b>Outgoing Calls</b> or <b>All Calls</b>. You can add contacts to <b>Shared Contacts</b> directly from call logs.</p>
<b>Voice Mail</b>	<ul style="list-style-type: none"> <li>• <b>Play Message:</b> Play voice mail messages received.</li> <li>• <b>Set Voice Mail:</b> Configure voice mail parameters.</li> </ul>
<b>Settings</b>	<ul style="list-style-type: none"> <li>• <b>Registration</b> Register and unregister your handset and also select base station.</li> <li>• <b>Handset Name</b> Change the handset's name.</li> <li>• <b>Phone Language</b> Select the language to be displayed on the phone's LCD. (Default is English.)</li> <li>• <b>Date/Time</b> Configure date and time on the Handset.</li> <li>• <b>Audio</b> Specify ringtones for internal/external calls, the volume, and advisory tones (Keypad, Confirmation, Low battery notifications).</li> <li>• <b>Display</b> Configure backlight, LCD timeout, LCD brightness and menu key timeout.</li> <li>• <b>Network Settings</b> Configure IP addresses and select DHCP/Static IP mode.</li> <li>• <b>SIP Settings</b> Configure/View SIP accounts settings.</li> <li>• <b>System settings</b> Change Base PIN code, perform factory reset, reboot base and configure repeater mode.</li> <li>• <b>User Settings</b> Configure auto answer feature, off-cradle pickup, on-cradle hangup, busy tone, call waiting tone, cradle backlight, onhook backlight, mute, arrow keys functions, and left / right soft keys function.</li> <li>• <b>Firmware Upgrade</b> Upgrade the firmware version of the handset.</li> <li>• <b>Factory Functions</b></li> </ul>



	<ul style="list-style-type: none"> <li>- <i>Diagnostic Mode</i> All LEDs will light up, and the LCD will display a table listing the names of all keys in red. Press any key to diagnose; the key's name will display in blue. After all keys are diagnosed, a prompt message ("PASS") will display; press "Back" (right softkey) to exit.</li> <li>- <i>Audio Loopback</i> Speak to the phone using speaker/handset/headset. If you can hear your voice, your audio is working fine. Press "Exit" softkey to exit audio loopback mode.</li> <li>- <i>LCD ON / OFF</i> Select this option to turn off LCD. Press any button to turn on LCD.</li> <li>- <i>LCD Diagnostic</i> Select this option to enter LCD Diagnostic mode. Press "Next" (left softkey) to display white screen. Continue pressing the left softkey to view all remaining screens (black, blue, red, and green) and then exit. End the test early by pressing the right softkey.</li> <li>- <i>System Monitoring</i> Displays RSSI and battery voltage information.</li> </ul>
<b>Call Settings</b>	<ul style="list-style-type: none"> <li>• <b>Do Not Disturb</b> Enable/disable do not disturb mode on the phone.</li> <li>• <b>Call Waiting</b> Configure call waiting feature.</li> <li>• <b>Call Forward</b> Configure call forward feature.</li> <li>• <b>Speed Dial</b> Assign contact numbers as speed dial.</li> <li>• <b>Outgoing Default Line</b> Select outgoing default line.</li> <li>• <b>Lines</b> Display the line status.</li> </ul>
<b>Status</b>	<ul style="list-style-type: none"> <li>• <b>Status</b> Display handset status (Model RF, Firmware, IP address, Subnet mask, Gateway, MAC Address, IPEI, ...)</li> </ul>



## BASIC OPERATIONS

### Turning the Handset ON / OFF

#### To turn ON the handset

- Long press on **Power key**  until the LCD screen lights up.

#### To turn OFF the handset

- Long press on **Power key**  again when the handset is idle until the display turns off.

### Setup Wizard

Setup wizard shows at first access to DP720 or factory reset allowing users to configure handset language and date/time. Users can quit at any time by pressing "**Skip**" (left softkey).

### Register DP720 Handset to DP750 Base Station

1. On DP750 Base station, press and hold the Radio/Page button for 7 seconds until the Radio icon starts blinking to start Subscription process. Or Access web UI, and press **Subscribe** icon  to **Open Subscription**.

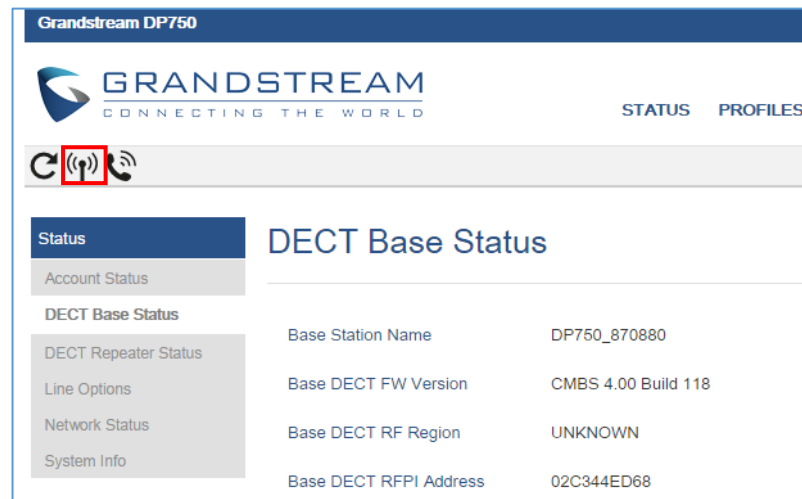

Figure 9: DECT Status - Subscribe

2. On DP720, press **Subscribe** softkey if available on the main screen or access **Menu** → **Settings** → **Registration** → **Register** while the DP750 Radio icon is blinking.

**Note:** "Subscribe" softkey appears only if DP720 is not registered to any DP750 base station.

3. Select **BaseX** (X=1-4) corresponding to the desired base station DP750, then press **Subscribe**.
4. The DP720 will search for nearby base stations and will display the RFPI code and base station name of the discovered DP750.
5. Press **Subscribe** to pair with the displayed DP750.
6. The DP720 will display **Easy Pairing** on the LCD and play an audible buzz when successful. Then it will return to the home screen, displaying the handset name and number assigned by the registered base station.

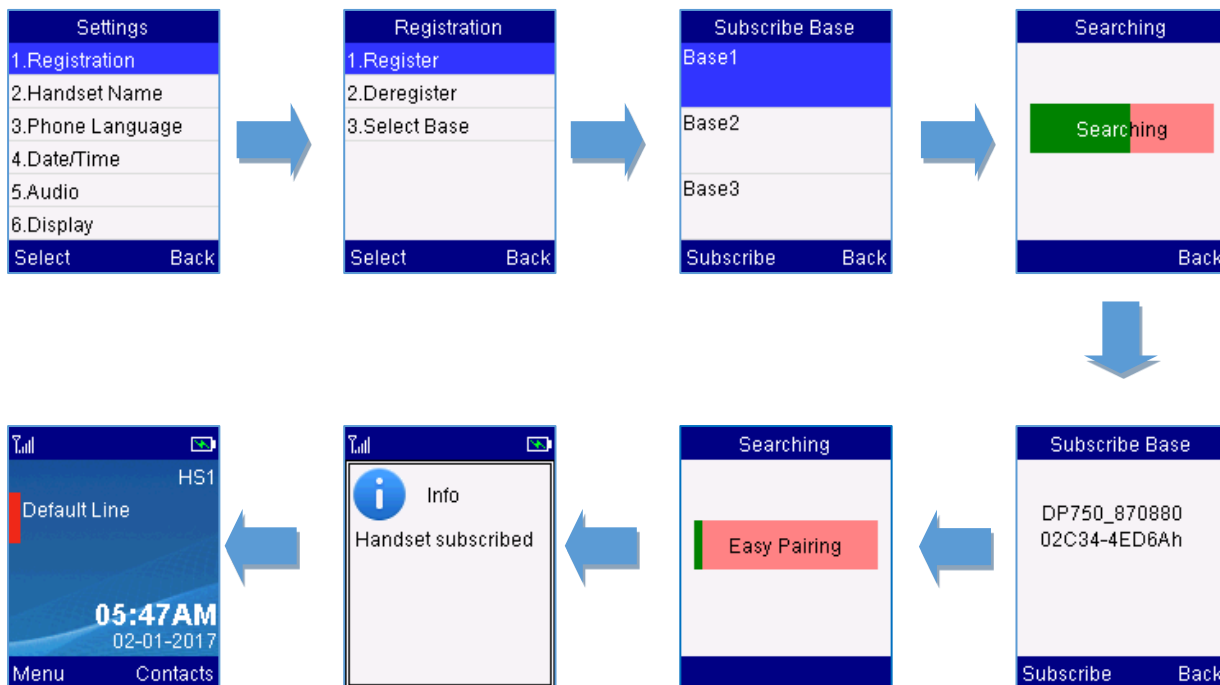





Figure 10: Registration process

## Using DP720 with Multiple DP750 Base Stations

DP720 is able to be registered to up four different DP750 base stations.

### Registering DP720 to an additional DP750 base station

Considering DP720 is previously registered to an initial base station, please follow below steps to register a handset to an additional base station:

1. Press **Menu** (left softkey  or the selection key  ) to bring up operation menu.
2. Use arrow keys to reach **Settings**  and navigate to **Registration**.
3. Select **Register**.

4. Navigate to an unsubscribed base using arrow keys and click on **Subscribe**.
5. Make sure that the subscription is opened on the new base station.

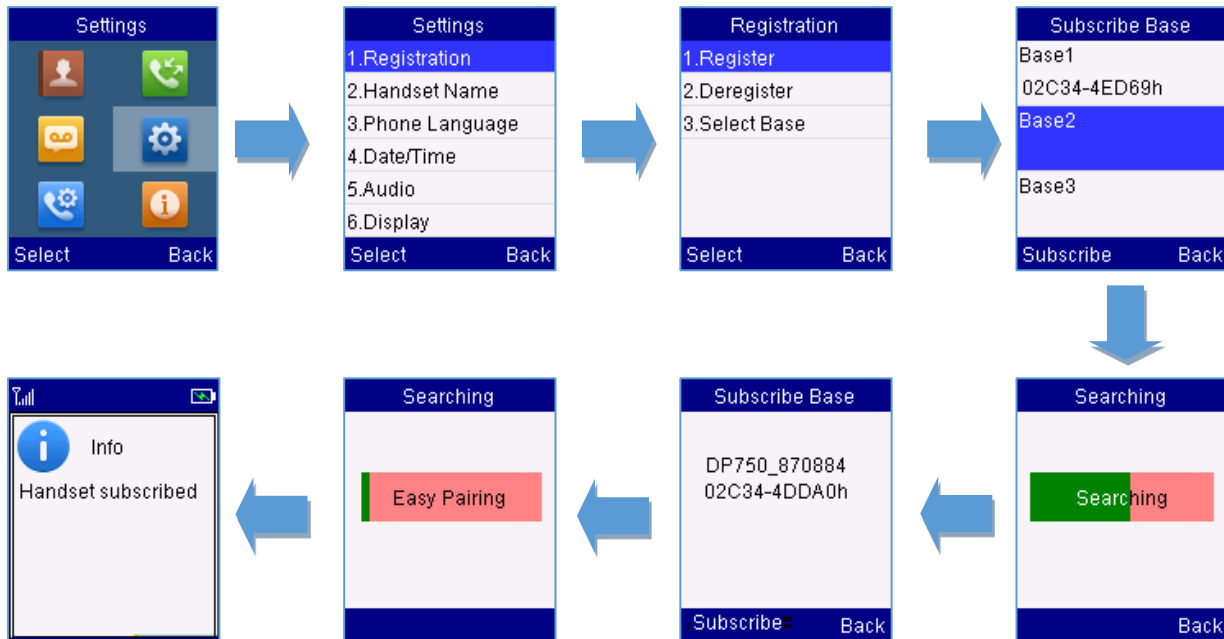





Figure 11: Multiple Base Stations Registration

### Switching Between Different Base Stations

1. Press “Menu” (left softkey  or the selection key  ) to bring up operation menu.
2. Use arrow keys to reach **Settings**  and select **Registration**.
3. Navigate to **Select Base** using arrow keys.
4. Select the desired base station and press **Select**.

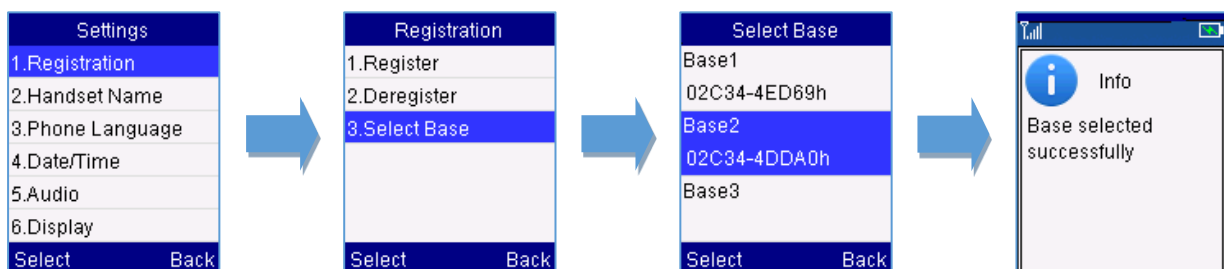







Figure 12: Switching Between Base Stations



## Unregister the DP720

- **Using DP720 Handset:**

1. On DP720, press “Menu” (left softkey  or the selection key  ) to bring up operation menu.
2. Press arrow keys to move the cursor to **Settings** and then press “Select”.
3. Navigate to **Registration**, then press “Select” (left softkey  ).
4. Navigate to **Deregister**.
5. Select the Handset to be unregistered and press “Deregister” (left softkey  ).
6. Enter the system PIN code (default: 0000).
7. Press “Done” (left softkey  ) to confirm or “Back” (right softkey  ) to cancel.

- **Using DP750 Base Station UI:**

1. Access DP750 Web Interface.
2. Go to **Status** → **DECT Base Status**.
3. Locate the handset to unregister and press “**Unsubscribe**” button.

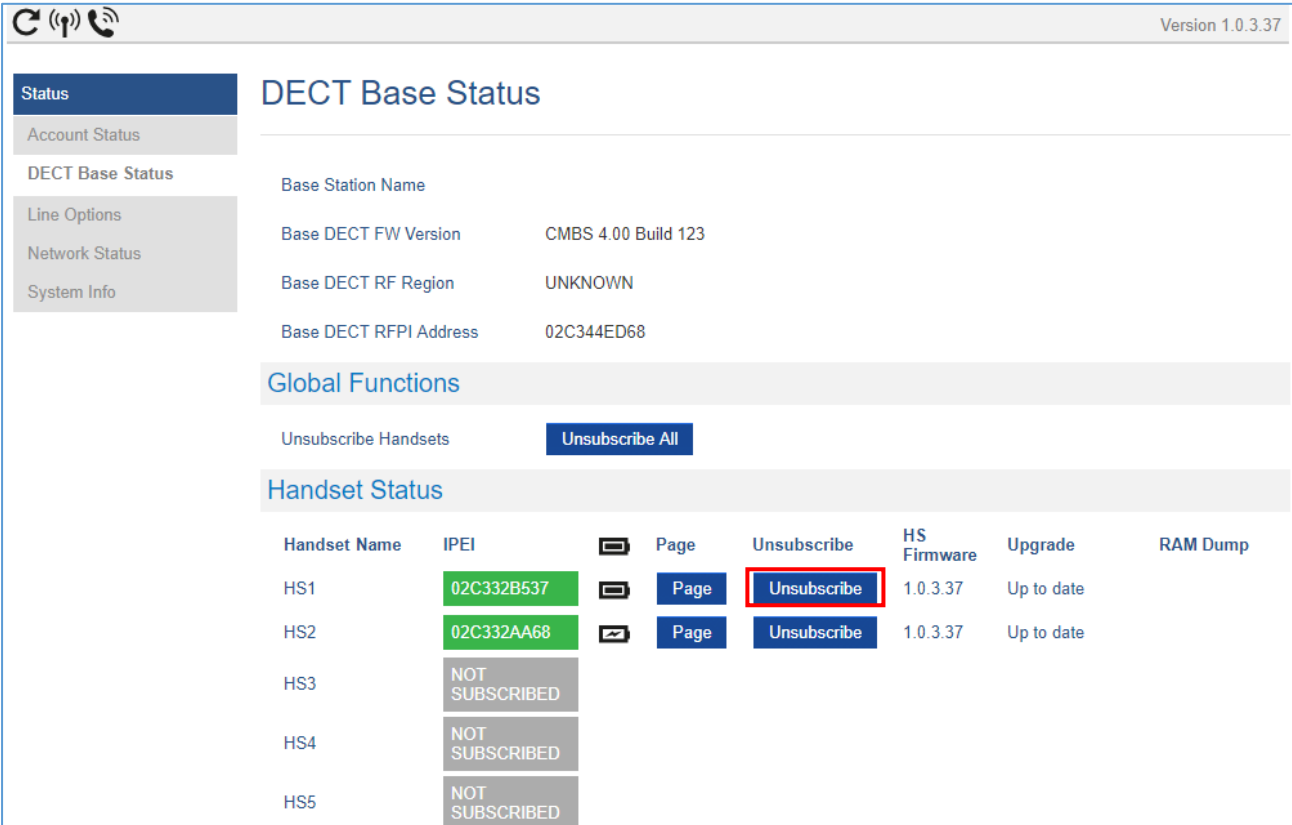





Handset Name	IPEI	Page	Unsubscribe	HS Firmware	Upgrade	RAM Dump
HS1	02C332B537	Page	Unsubscribe	1.0.3.37	Up to date	
HS2	02C332AA68	Page	Unsubscribe	1.0.3.37	Up to date	
HS3	NOT SUBSCRIBED					
HS4	NOT SUBSCRIBED					
HS5	NOT SUBSCRIBED					

Figure 13: Unregister DP720 from DP750 web UI

## Obtain DP750 Base Station IP Address via paired DP720

DP750 is by default configured to obtain IP address from DHCP server where the unit is located. In order to know which IP address is assigned to your DP750, please follow below steps using a paired DP720 handset with your DP750 base station. Please see [Register DP720 Handset to DP750 Base Station](#) .

1. Press “Menu” (left softkey)  or **OK** button  on DP720 to view operation menu.
2. Press Arrow (Up, Down, Left, Right) keys to move the cursor to **Status** icon  , then press “Select” (left softkey)  or **OK** button .

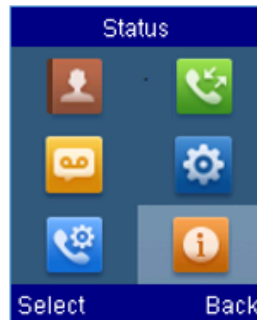



3. Using arrow keys, navigate down to view the IP address of the DP750.



## Setting the Key Lock

You can lock the keypad against unintentional entries. It is, however, still possible to pick up incoming calls even with the keypad locked.

### • To enable the Keypad Lock

1. Press the **Pound key “#”**  and hold for approximately 2 seconds.
2. The display shows Keypad Locked briefly and the key lock icon  appears in the display.



- **To disable the Keypad Lock**

1. Press and hold **Pound key “#”**  to unlock the keys.
2. Keypad Unlocked appears briefly in the display and a windows prompt will be displayed to confirm that the keypad is unlocked.

## Locating a DP720 Handset from DP750 Base station

In some situations, you may have a DP720 handset incorrectly positioned and you don't know its current location. You can locate a DP720 handset from his registered DP750 base station using below steps:

### Locate via DP750 Web UI

1. Access the Web GUI of your DP750 using the admin's username and password. (Default username and password is: admin/admin).
2. Press **Login** to access your settings and navigate to **Status** → **DECT Base Status** tab.
3. Choose which handset to locate and press its corresponding **Page** button.

**Note:** If you press **Page All** icon , all registered DP720 handsets will be receiving paging call.

4. A paging call will be received on the selected DP720 handset.
5. Once located, you can press any key on the handset or press **Page** or **Page All** to end paging call.

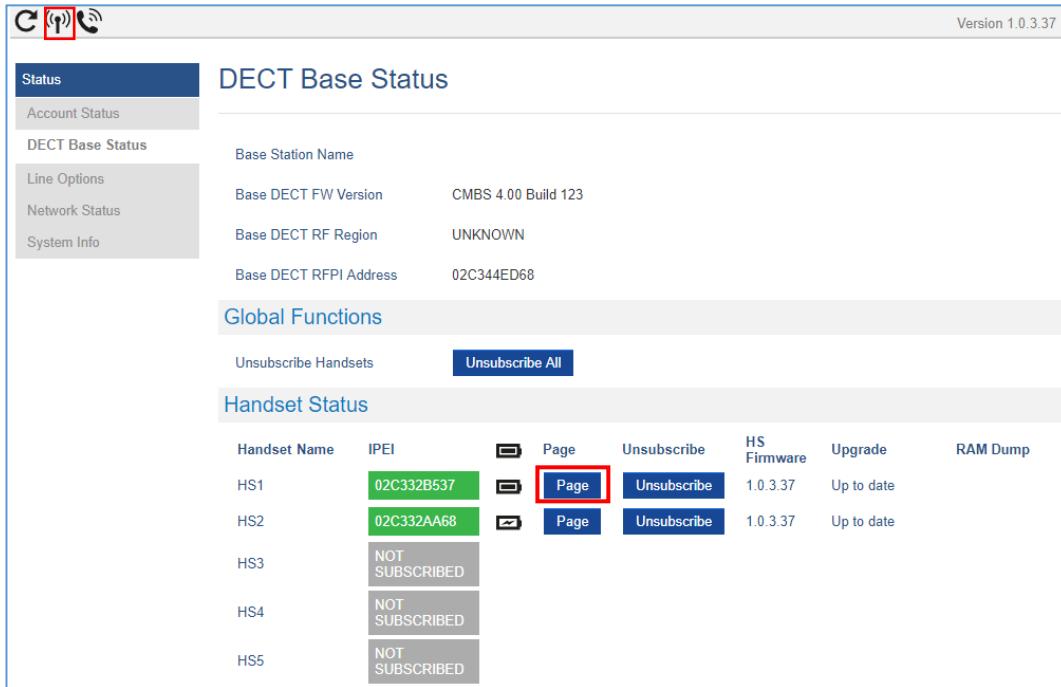

The screenshot shows the 'DECT Base Status' page in the web UI. The page includes a sidebar with navigation options like 'Status', 'Account Status', 'DECT Base Status', 'Line Options', 'Network Status', and 'System Info'. The main content area displays base station information, global functions (including an 'Unsubscribe All' button), and a 'Handset Status' table. The 'Handset Status' table has columns for Handset Name, IPEI, Page, Unsubscribe, HS Firmware, Upgrade, and RAM Dump. The 'Page' button for handset HS1 is highlighted with a red box.

Handset Name	IPEI	Page	Unsubscribe	HS Firmware	Upgrade	RAM Dump
HS1	02C332B537	<b>Page</b>	Unsubscribe	1.0.3.37	Up to date	
HS2	02C332AA68	Page	Unsubscribe	1.0.3.37	Up to date	
HS3	NOT SUBSCRIBED					
HS4	NOT SUBSCRIBED					
HS5	NOT SUBSCRIBED					

Figure 14: Locate Handset via Web UI

## Locate via DP750 Base station

1. On DP750 Base station back side, press **Radio/Page** button  .
2. All registered handsets will receive Paging call.
3. Once located, you can end the paging calling by pressing any key on the handsets or by pressing again **Radio/Page** button.



## Checking System Status

You can view the system status on your handset including the following information of the system:

Table 9: DP720 Info description

Item	Description
<b>Model (RF)</b>	Displays the product model, hardware version and DECT region of DP720. i.e.: <b>DP720 1.4A (EU)</b>
<b>Firmware</b>	Current firmware version installed on DP720.
<b>IP Address</b>	IP address of the base station DP750 if registered.
<b>Subnet Mask</b>	Subnet Mask of the base station DP750 if registered.
<b>Gateway</b>	Gateway IP of the base station DP750 if registered.
<b>MAC address</b>	MAC address of the base station DP750 if registered.
<b>IPEI</b>	International Portable Equipment Identifier. Unique "serial number" for DECT handsets.







- **To check the handset status**

1. Press **Menu** (left softkey  or the selection key  ) to bring up operation menu.
2. Use arrow keys to reach **Status** menu  .

## Basic Network Settings

Once connected to the network, DP750 base station will attempt to contact a DHCP server to obtain valid network settings (e.g., IP address, subnet mask, gateway address and DNS address) by default.

The users could also configure basic network settings manually from a registered DP720 Handset. In order to configure the network settings manually, please follow the steps below:

1. Press **Menu** (left softkey  or the selection key  ) to bring up operation menu.
2. Use arrow keys to reach **Settings**  and access **Network Settings** menu.
3. Enter the system PIN code (default: 0000) and press the softkey “**Done**” (left softkey  ).
4. To change to static IP, press  or  to select **Static** from the **IP Settings** field.
5. Enter valid values in the **IP Address**, **Subnet Mask**, **Gateway**, **DNS Server** fields.
6. Press softkey “**Save**” (  ) to save and apply the new changes.
 

**Note:** A prompt message will be displayed to confirm that the new settings are saved successfully
7. The DP720 will display a reboot confirmation message, select “**Yes**” to apply the new settings or “**No**” to avoid rebooting the DP750.

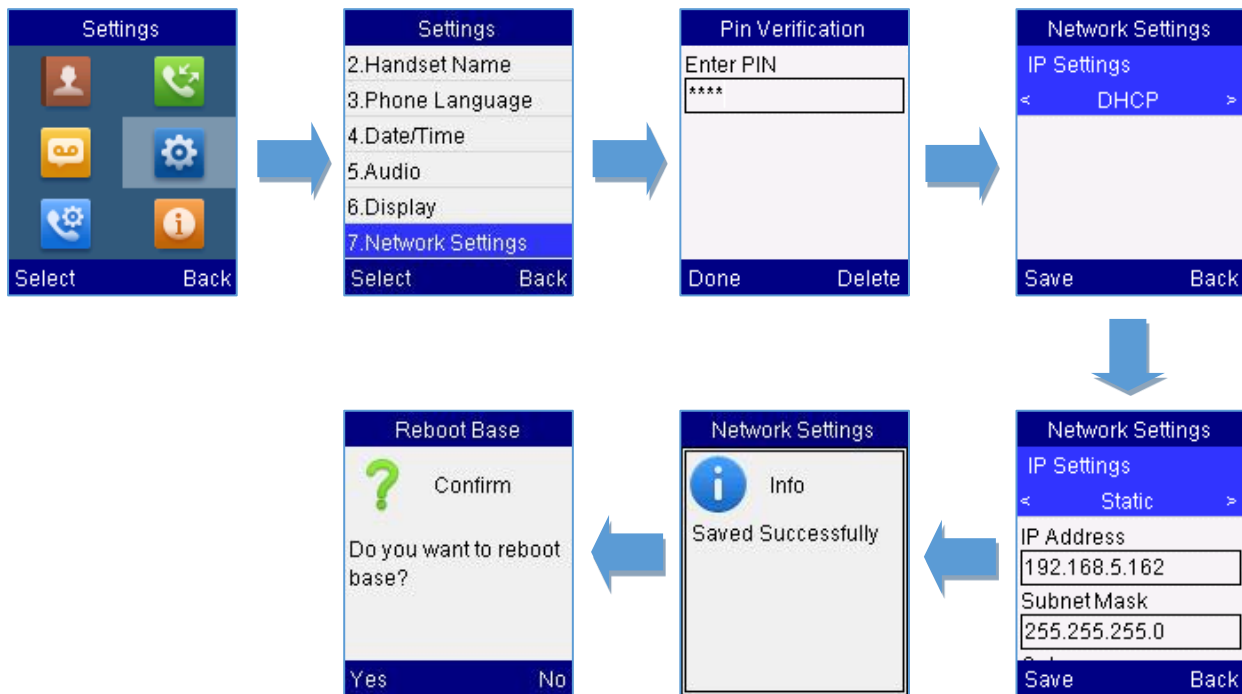







Figure 15: Network Settings configuration

## Change Menu and LCD Timeout

1. Press **Menu** (left softkey  or the selection key  ) to bring up operation menu.
2. Use arrow keys to reach **Settings**  .
3. Navigate to **Display**, and then press “**Select**” (left softkey  ).



4. Set desired time in seconds for Backlight timeout and for Menu timeout. Available value: 15 seconds, 30 seconds, 60 seconds or disabled. (Default is 30 seconds)
5. Press **Save** (left softkey ) to save and apply the new settings.

## Return to Idle Screen

Press the **Power Key**  to quickly exit the menu and return back to the main idle screen.

If you do not press any key in a period of time, the LCD screen will automatically exit the menu and return to the idle screen as well.

When you are navigating on the handset's menu, and you receive an incoming call, the LCD screen will automatically exit the menu and you can either accept or reject the call, when the call is terminated, the LCD screen will return back to the idle screen.

## Register a SIP Account

DP750 supports up to 10 SIP accounts, 5 handsets. Each handset can be configured up to 10 accounts. Please be aware that line settings will be affected by DID settings (hunting group settings) in "DECT → SIP Account Settings". For more details about "Hunting Group", please refer to "[Administration Guide](#)".

### Register Account via Web User Interface

1. Access your DP750 base station web UI by entering its IP address in your favorite browser.
2. Enter your admin's username and password (default username and password: admin/admin).
3. Press **Login** to access your settings.
4. Go to **Profiles** tab and select a profile to use.

DP750 supports up to 4 profiles. A profile is a set of settings including general settings, network settings, SIP setting, audio setting, call settings and ring tones, etc.

A profile can be used with different SIP accounts.

5. In **General Settings**, set the following:
  - a. **Profile Active** to **Yes**.
  - b. **SIP Server** field with your SIP server IP address or FQDN.
  - c. **Failover SIP Server** with your failover SIP server IP address or FQDN. Leave empty if not available.



- d. **Prefer Primary SIP Server** to **No** or **Yes** depending on your configuration. Set to **No** if no failover SIP server is defined. If “**Yes**”, account will register to primary SIP server when failover registration expires.
  - e. **Outbound Proxy** with your outbound proxy IP address or FQDN. Leave empty if not available.
6. Press **Save and Apply** to save your configuration.
  7. Go to **DECT → SIP Account Settings**

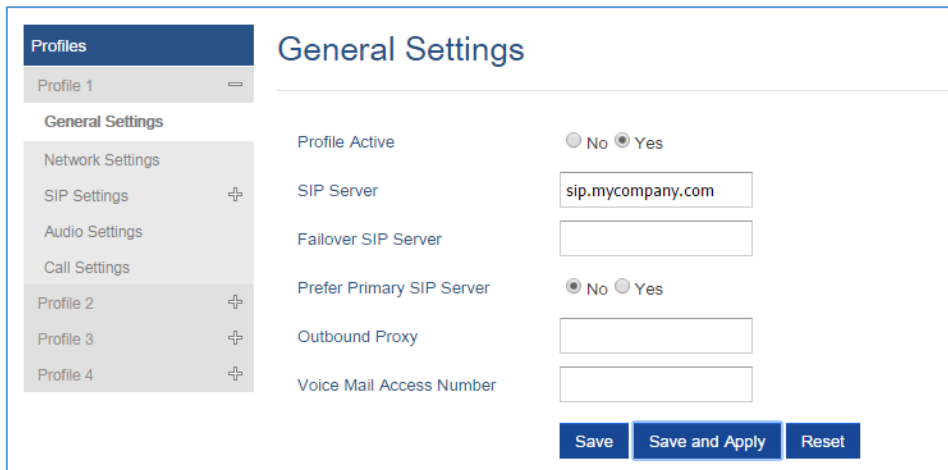

**Figure 16: SIP Settings**

8. Configure your SIP details in desired account:
  - a. **Account:** Select Account row to configure (Account 1 – Account 10).
  - b. **SIP User ID:** User account information, provided by VoIP service provider (ITSP). Usually in the form of digit similar to phone number or actually a phone number.
  - c. **Authenticate ID:** SIP service subscriber’s authenticate ID used for authentication. Can be identical to or different from SIP User ID.
  - d. **Password:** SIP service subscriber’s account password to register to SIP server of ITSP. For security reasons, the password will field will be shown as empty.
  - e. **Name:** Any name to identify this specific user.
  - f. **Profile:** Select the corresponding Profile ID (1/2/3/4).
  - g. **HS Mode:** Assign the account to specific handset (HS1, HS2...) or hunting group mode.
  - h. **Active:** Set to **Yes**. If set to **No**, account is disabled and will not register.
9. Press **Save and Apply** to save your configuration.

**DECT**

General Settings

**SIP Account Settings**

Handset Line Settings

## SIP Account Settings

Account	SIP User ID	Authenticate ID	Password	Name	Profile	HS Mode	Active
Account 1	1400	1400	.....	1400	Profile 1 ▼	HS 1 ▼	<input type="radio"/> No <input checked="" type="radio"/> Yes
Account 2	1401	1401	.....	1401	Profile 1 ▼	Circular ▼	<input type="radio"/> No <input checked="" type="radio"/> Yes
Account 3	1402	1402	.....	1402	Profile 1 ▼	Circular ▼	<input type="radio"/> No <input checked="" type="radio"/> Yes
Account 4	1403	1403	.....	1403	Profile 1 ▼	Circular ▼	<input type="radio"/> No <input checked="" type="radio"/> Yes
Account 5					Profile 1 ▼	Circular ▼	<input type="radio"/> No <input checked="" type="radio"/> Yes
Account 6					Profile 1 ▼	Circular ▼	<input type="radio"/> No <input checked="" type="radio"/> Yes
Account 7					Profile 1 ▼	Circular ▼	<input type="radio"/> No <input checked="" type="radio"/> Yes
Account 8					Profile 1 ▼	Circular ▼	<input type="radio"/> No <input checked="" type="radio"/> Yes
Account 9					Profile 1 ▼	Circular ▼	<input type="radio"/> No <input checked="" type="radio"/> Yes
Account 10					Profile 1 ▼	Circular ▼	<input type="radio"/> No <input checked="" type="radio"/> Yes

Save Save and Apply Reset

**Figure 17: SIP Accounts Settings**

After applying your configuration, your phone will register to your SIP Server.

You can verify if your DECT phone has registered with your SIP server from your DP750 web interface under Status → Account Status (a green background with Yes under SIP Registration column for corresponding account indicates the account has been successfully registered).

**Status**

Account Status

DECT Status

Line Options

Network Status

System Info

## Account Status

Account	SIP User ID	SIP Server	SIP Registration	HS Mode	HS1	HS2	HS3	HS4	HS5
Account 1	1400	192.168.6.30	YES	HS 1	📞	📞	📞	📞	📞
Account 2	1401	192.168.6.30	YES	Circular	📞	📞	📞	📞	📞
Account 3	1402	192.168.6.30	YES	Circular	📞	📞	📞	📞	📞
Account 4	1403	192.168.6.30	YES	Circular	📞	📞	📞	📞	📞
Account 5			N/A		📞	📞	📞	📞	📞
Account 6			N/A		📞	📞	📞	📞	📞
Account 7			N/A		📞	📞	📞	📞	📞
Account 8			N/A		📞	📞	📞	📞	📞
Account 9			N/A		📞	📞	📞	📞	📞
Account 10			N/A		📞	📞	📞	📞	📞

**Figure 18: Account Status**



## PHONE SETTINGS

This chapter will help you with the instruction for configuring and changing the settings of your DP720,

### Editing the Handset's name

The procedure to change the handset's name is as follows:

- **Using DP720 Handset:**





1. Press **Menu** (left softkey  or the selection key  ) to bring up operation menu.
2. Use arrow keys to reach **Settings**  .
3. Navigate to select **Handset Name**, and then press "Select" (left softkey  ).
4. Enter the desired name and press "Rename" (left softkey  ) and then the DP720 will display a confirmation message that the rename operation was successful.



Figure 19: Handset Name editing

- **Using DP750 Base Station UI:**

1. Access DP750 Web Interface.
2. Go to **DECT → General Settings**.
3. In "Handset Settings" section, change **Handset Name** to desired name.





Handset Settings			
Handset	Handset Name	Handset Phonebook	Offhook Auto-dial
HS1	<input type="text" value="HS1"/>	PB1 ▼	<input type="text"/>
HS2	<input type="text" value="HS2"/>	PB2 ▼	<input type="text"/>
HS3	<input type="text" value="HS3"/>	PB3 ▼	<input type="text"/>
HS4	<input type="text" value="HS4"/>	PB4 ▼	<input type="text"/>
HS5	<input type="text" value="HS5"/>	PB5 ▼	<input type="text"/>

Figure 20: Edit Handset Name from DP750

## Changing the Base PIN Code

Users can change their code PIN by following the steps below:

- **Using DP720 Handset:**

1. Press **Menu** (left softkey  or the selection key  ) to bring up operation menu.
2. Use arrow keys to reach **Settings**  .
3. Navigate to select **System Settings**, and then press “Select” (left softkey  ).
4. Enter the current code PIN (By Default is 0000), a new window will be displayed inviting you to enter the new password, when done press “**Save**” (left softkey  ) and a prompt message will be displayed to confirm that the new code PIN has been saved successfully.

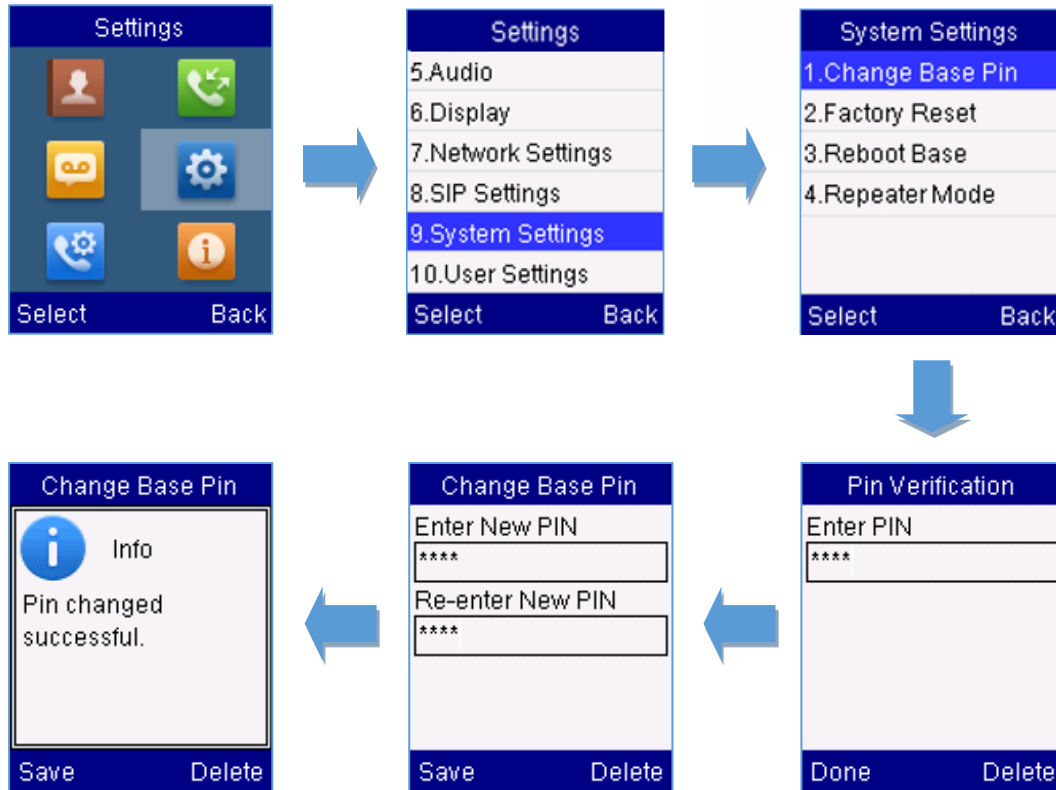

Figure 21: Changing Admin Base PIN Code from DP720

- **Using DP750 Base Station UI:**

1. Access DP750 Web interface.
2. Go to **DECT** → **General Settings**.
3. Set new PIN code in **Admin PIN Code** field.

Note: Only digits accepted. Minimum allowed length is 4 digits.

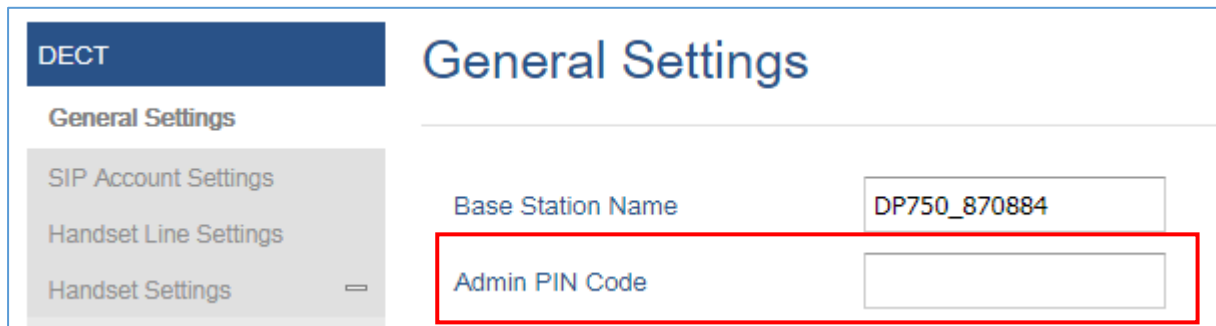

Figure 22: Changing Admin Base PIN Code from DP750



## Selecting Phone Language

The DP720 supports displaying texts in different languages. The handset supports 27 languages (see the table of the technical specifications). The default language of the handset is English. You can change the language according to your requirement. To change the language of the handset, please proceed as follows:







1. Press **Menu** (left softkey  or the selection key  ) to bring up operation menu.
2. Use arrow keys to reach **Settings**  .
3. Navigate to select **Phone language**, then select the desired language and press “Select” (Left softkey  ). The LCD screen prompts “Change phone language to xxx (xxx it’ the language you selected)”
4. Press “Yes” (left softkey  ) to accept the change. Text displayed on the handset will change to the selected language.





Figure 23: Handset Language

## Activate/Deactivate Hands-Free Mode



This function allows you to make a call without having to hold the handset in your hand.

1. Press the **Hands-free key**  while you are making a call or on the idle screen to activate hands free mode.
2. Press the **Hands-free key**  again to deactivate the hands-free function.

## Muting the Microphone

Press the **Mute key**  to switch off the microphone during an established call. You can now talk freely without the other party hearing you and the icon of mute  will be displayed on the screen. Press the **Mute key**  again to switch the microphone back on.

## Adjusting Speaker and Earpiece Volume

Press left key  or right key  while you are on an established call to set the volume of the earphone / speaker. You can choose between 5 different levels. The default level is 3:

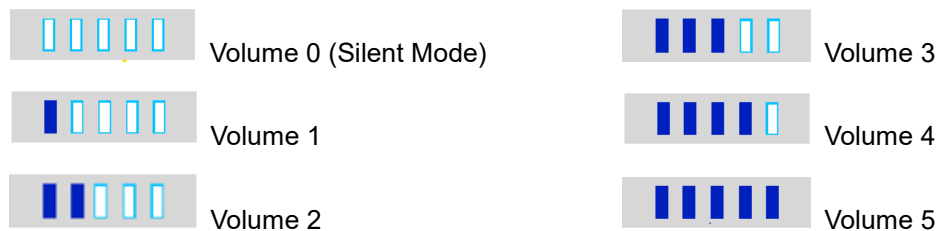





## Ringtones

### Setting the Ringer Volume on the Handset

You can adjust the ringer volume for an incoming call to one of 6 levels (level 1 to 5 and off). Level 5 is the highest level. (The DP720 Handset is set to level 3 by default).

In order to configure the desired ringer volume, proceed as follows:

1. Press **Menu** (left softkey  or the selection key  ) to bring up operation menu.
2. Use arrow keys to reach **Settings**  .
3. Navigate to select **Audio** → **Volume**.
4. Press the left and right arrow keys to change repeatedly and set the desired volume.
5. Press “Save” (left softkey  ) to confirm the volume, and a message prompt will be displayed to confirm that the new volume has been successfully saved.

If you select **OFF**, the icon  appears in the display and the handset will not ring for incoming calls.

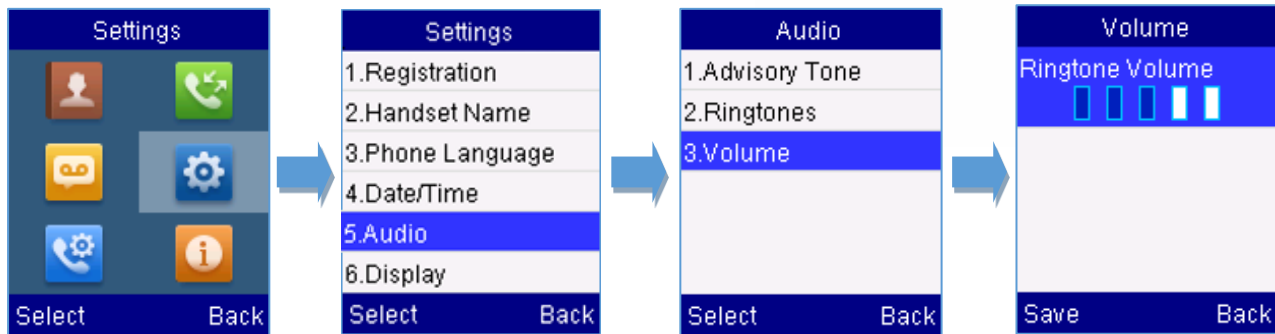





**Figure 24: Ringer Volume**

### Setting the Ringer Melody on the Handset

You can change the ringer melody for an incoming call. The device has 8 different ringer melodies for you to choose from (1-8). The default setting for the ring tone for a call is melody 1.

In order to configure the desired melody, proceed as follows:

1. Press **Menu** (left softkey  or the selection key  ) to bring up operation menu.
2. Use arrow keys to reach **Settings**  .
3. Navigate to select **Audio** → **Ringtones**.
4. Press “Select” (left softkey  ) to confirm the ringtones selected and a message prompt will be displayed to confirm that the new ringtones has been set successfully.

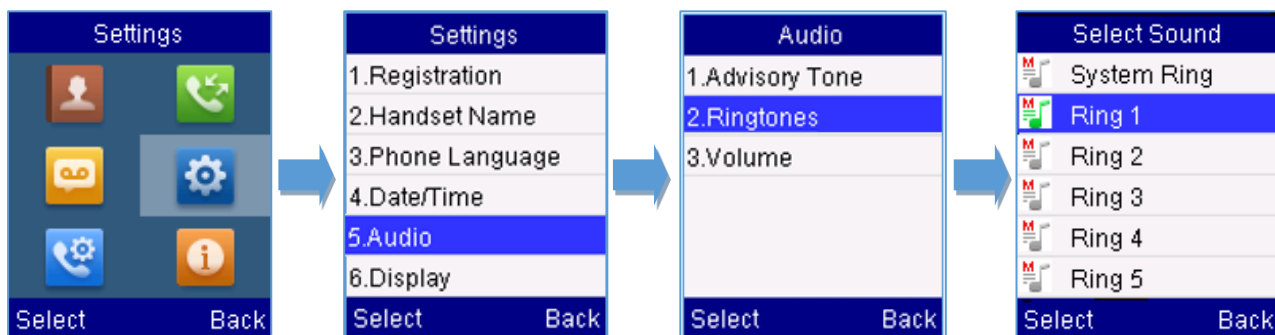





**Figure 25: Calls Ringtones**

## Advisory Tones

Advisory tones are acoustic signals, which inform you of different actions and states on your handset. The following advisory tones can be configured independently of each other:

- **Keypad tone:** it's played when a user presses any key of the keypad (even during calls).
- **Confirmation:** it's played when a user saves settings or places the handset in the charger cradle.
- **Low battery:** it's played if the capacity of the batteries is low or the handset requires charging.

### To configure the advisory tones

1. Press **Menu** (left softkey  or the selection key  ) to bring up operation menu.
2. Use arrow keys to reach **Settings**  .
3. Navigate to select **Audio** → **Advisory tones**, and choose which tone you want to change it.
4. Press the left and right arrow keys to either enable or disable the desired tones.
5. Press “Save” (left softkey  ) to confirm, and a message prompt will be displayed to confirm that the new settings has been successfully saved.

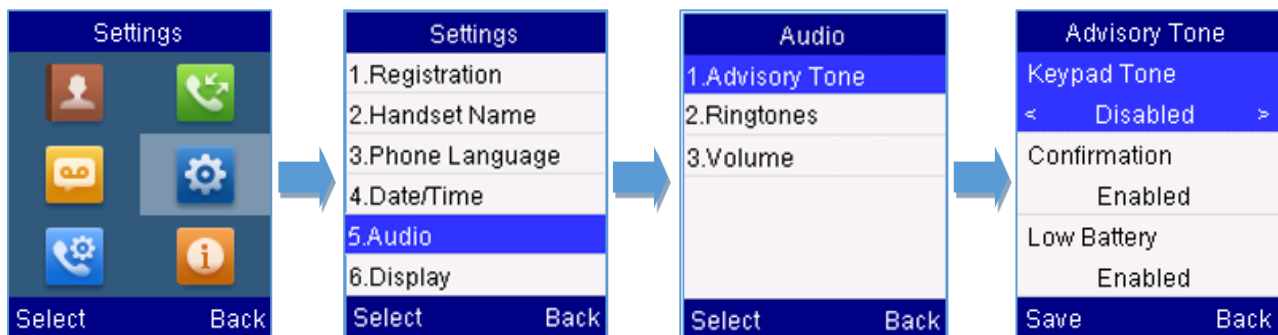

Figure 26: Advisory Tone

## Ringtones Customization

DP750/720 allow users to use custom ringtones. Custom ringtones will be stored on DP750 base station and only selected custom ringtone will be downloaded to specific DP720 handset.

DP750 base station supports up to 10 custom ringtones.

Custom ringtone should be generated using GS Ringtone Tool and named **ring[1-10].bin** (example: ring1.bin , ring6.bin).

To use custom ringtones, follow below steps:

### Step 1: Generate Custom Ringtone(s)

1. Download “Ringtone Generator” tool available at <http://www.grandstream.com/support/tools>
2. Run the tool and select your ringtone file to convert.

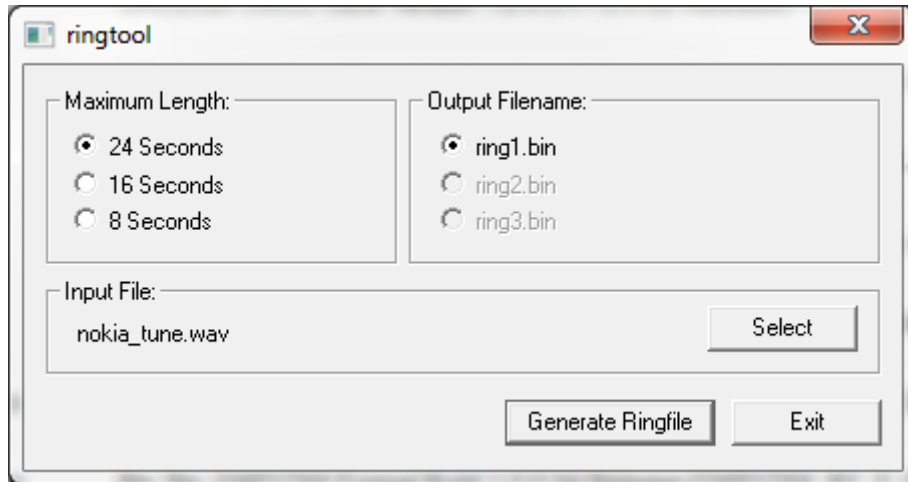

Figure 27: Generating Custom Ringtone (Windows)

#### Notes:

Currently only 16-bit linear PCM audio is supported for .wav files. The sampling rate should be automatically detected and the audio will automatically be down sampled to 8kHz. Stereo channels are also detected and mixed to produce mono output.

.pcm files should be pre-formatted to 16-bit 8kHz mono format.

3. Press “Generate Ringfile” to finish the process. Ringtone with filename “ring1.bin” will be created at same location as ringtone tool.

### Step 2: Download Custom Ringtone(s) to DP750 Base Station

1. Make generated ringtone files available in your TFTP, HTTP or HTTPS server.
2. Access DP750 Web GUI and go **Maintenance** → **Firmware Upgrade** page.
3. Set “**Upgrade Via**” to TFTP, HTTP or HTTPS (depending on server type hosting ringtone files).
4. Set “**Firmware Server Path**” to IP address or the FQDN of the server.
5. Set “**Firmware Upgrade and Provisioning**” to “Always Check for New Firmware”.
6. Update the change by clicking the “**Save and Apply**” button. Then “**Reboot**” or power cycle the base station to download the ringtone(s).





**Maintenance**

**Firmware Upgrade**

- Provisioning
- Web/SSH Access
- TR-069
- Security Settings +
- Date and Time
- Syslog
- Packet Capture
- Factory Reset
- Support +

## Firmware Upgrade

---

### Base Firmware

Firmware Upgrade  Always Check for New Firmware  
 Check New Firmware Only When F/W pre/suffix Changes  
 Always Skip the Firmware Check

HTTP/HTTPS User Name

HTTP/HTTPS Password

Always send HTTP Basic Authentication Information  No  Yes

Verify host when using HTTPS  No  Yes

Upgrade via  TFTP  HTTP  HTTPS

Firmware Server Path

Firmware File Prefix

Firmware File Postfix

Allow DHCP Option 43 and Option 66 to Override Server  No  Yes

Automatic Upgrade  No  
 Yes, check for upgrade every  minute(s)  
 Yes, check for upgrade every day  
 Yes, check for upgrade every week

**Figure 28: Downloading Custom Ringtones**

### Step 3: Assigning a Custom Ringtone for a DP720 Handset

1. Access DP750 Web GUI and go **DECT** → **HS Settings** → **HS# Settings** page.
2. In **Custom Ringtone**, select a custom ringtone from the dropdown list.

Note: If the list is not showing downloaded custom ringtone(s), press  and check again.

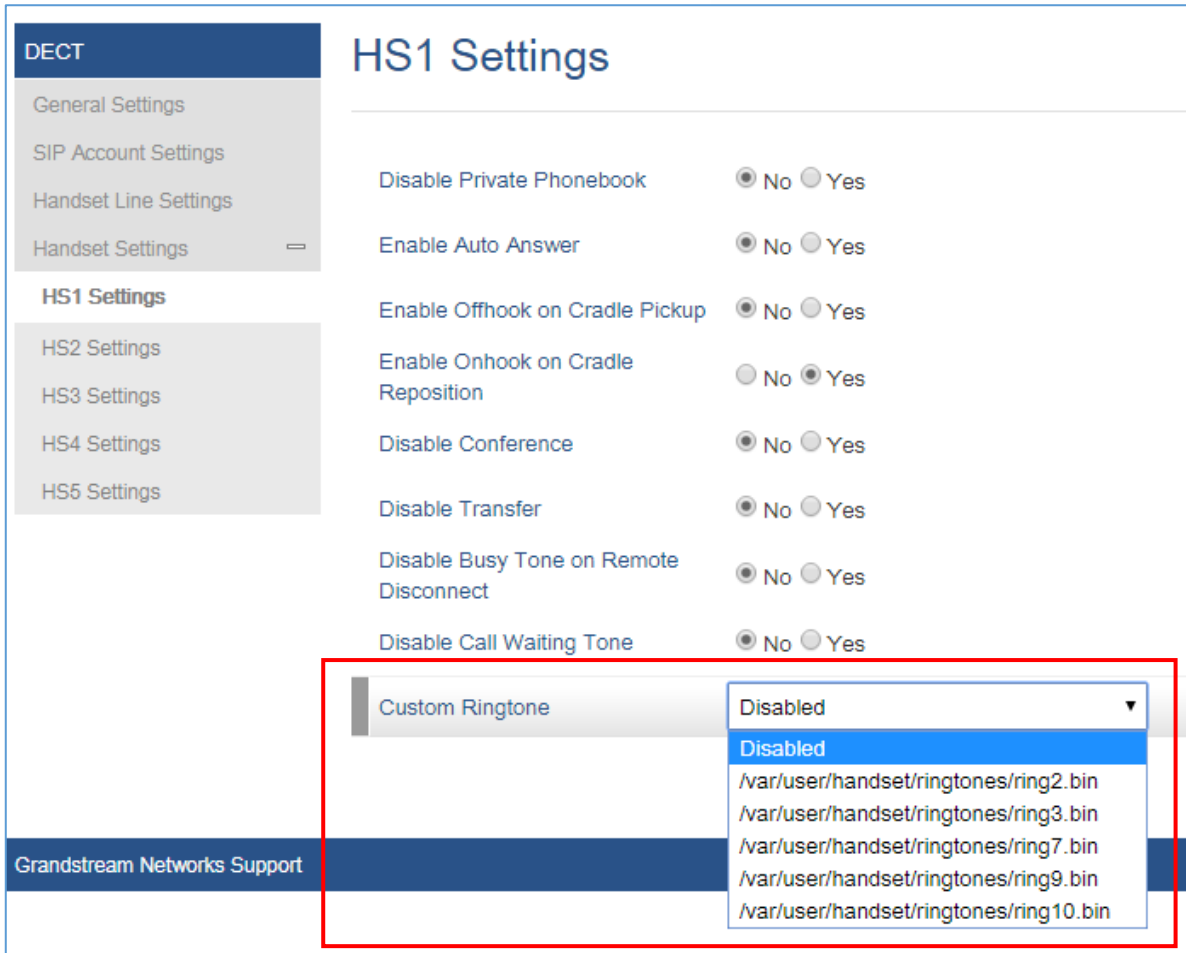

Figure 29: Custom Ringtone on DP750

3. Press “Save and Apply”. DP720 handset will download the ringtone locally before using it. (DP720 LCD screen will display download progress at this stage).
4. On DP720 Handset menu, access Settings → Audio → Ringtones. Select **Custom Ringtone** using up/down arrow keys and press “Select” softkey.



Figure 30: Custom Ringtone on DP720







**Note:** DP720 handset can use one custom ringtone only.



## Date and Time

On the DP720 the Date and time are displayed on the idle screen and it obtains the date and time from the Simple Network Time Protocol (SNTP) server by default. If your handset cannot obtain the date and time from the SNTP server, you need to configure the date and time manually. You can configure the time format and date format respectively. The handset supports two formats for time (12 Hour or 24 Hour) and three date formats (DD/MM/YYYY; MM/DD/YYYY; YYYY/MM/DD).

### To configure date and time manually

1. Press **Menu** (left softkey  or the selection key  ) to bring up operation menu.
2. Use arrow keys to reach **Settings**  .
3. Navigate to **Date and time**. Edit the current values in the Date & Time fields (you can change the date / time format using the left key  or right key  and press “Set” (left softkey  ).
4. Press “Save” softkey to apply your changes.

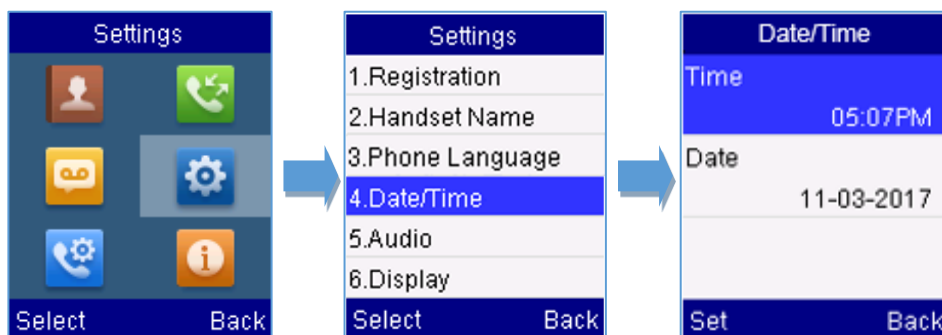



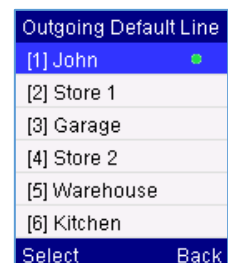

Figure 31: Date and Time Settings

## Outgoing Default Line

When a handset is configured with more than one line, users can change the default outgoing line on DP720 handset using the keypad menu by following the steps below:





1. Press **Menu** (left softkey  or the selection key  ) to bring up operation menu and access **Call settings**  → **Outgoing Default Line**.
2. The LCD screen displays all outgoing lines currently assigned to the handset. Default outgoing line is highlighted with green button  , select the desired line and press “Select” softkey.



## Factory Functions

The factory functions include the following diagnostic options:

- **LCD diagnostic**
- **LCD on / off**
- **Audio loopback**
- **Diagnostic mode**

1. Press **Menu** (left softkey  or the selection key  ) to bring up operation menu.
2. Use arrow keys to reach **Settings**  .
3. Navigate to select **Factory Functions** and choose which diagnostic, you need to perform, and then press “Select” (left softkey  ).

### - **Diagnostic mode**

All LEDs will light up. All keys' name will display in red on LCD screen before diagnosing. Press any key on the keypad to diagnose the key's function. When done, the key's name will display in blue on LCD with a prompt message (**PASS**). To exit press “Back” (right softkey  ).

### - **Audio loopback**

Speak to the phone using speaker/handset/headset. If you can hear your voice, your audio is working fine. Press “Back” (left softkey  ) to exit audio loopback mode.

### - **LCD ON / OFF**

Selects this option to turn off LCD. Press any button to turn on LCD.

### - **LCD Diagnostic**

Enters this option and press Left/Right arrow key to do LCD Diagnostic (you will notice that the color of the LCD will be changing). Press right softkey  to quit.

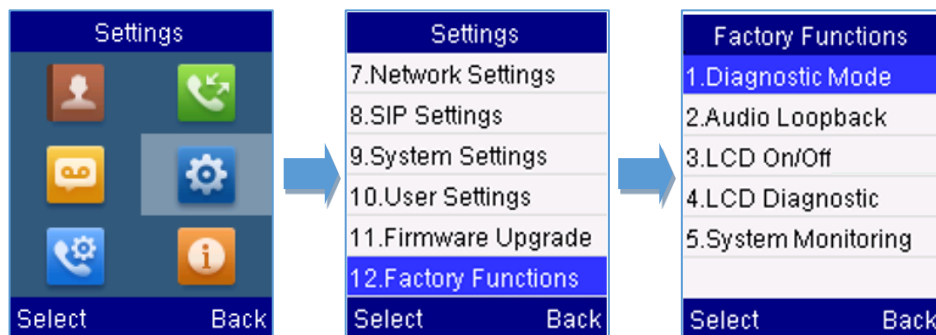

Figure 32: Factory Functions

## DP720 Handset Firmware Upgrade

The DP720 handset can detect if a new firmware is available when it is registered to a base station.

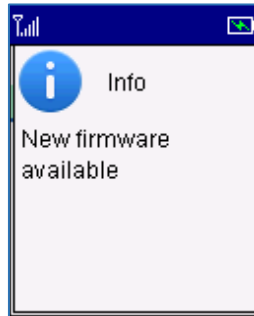





Figure 33: New Firmware Available Notification

To upgrade the firmware on your handset, follow the steps below:

1. Press **Menu** (left softkey  or the selection key  ) to bring up operation menu.
2. Use arrow keys to reach **Settings**  .
3. Navigate to select **Firmware Upgrade** and press the softkey “Select”.
4. The LCD screen will display a prompt message to confirm the firmware downloading / upgrading press the right softkey “Back” to dismiss the upgrade process.

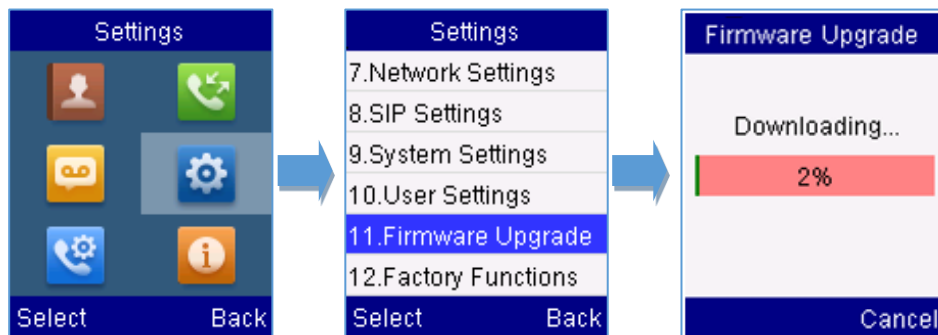







Figure 34: Firmware Upgrade

## Reboot DP750 Base Station

1. Press **Menu** (left softkey  or the selection key  ) to bring up operation menu.
2. Use arrow keys to reach **Settings**  .
3. Navigate to select **Settings** → **System Settings** and choose **Reboot Base**.
4. Enter Base PIN code (by default the PIN code is: 0000).
5. The LCD screen will display a prompt message to confirm rebooting the base station, press “Yes” (left softkey ) to confirm or press “No” (right softkey ) to cancel.



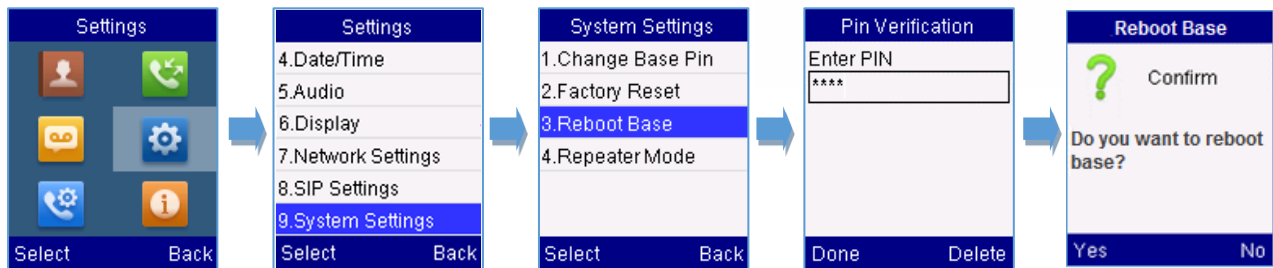







Figure 35: Rebooting the Base Station

## Reset DP720 Handset

The users can reset the new settings made on the handset after performing factory reset. To reset your handset to the default settings:

1. Press **Menu** (left softkey  or the selection key  ) to bring up operation menu.
2. Use arrow keys to reach **Settings**  .
3. Navigate to select **Settings** → **System Settings** and choose **Factory Reset**.
4. The LCD screen will display a prompt message to confirm restoring factory settings, press “Yes” (left softkey ) to confirm and then the handset will reboot to apply the default settings or press “No” (right softkey ) to cancel.

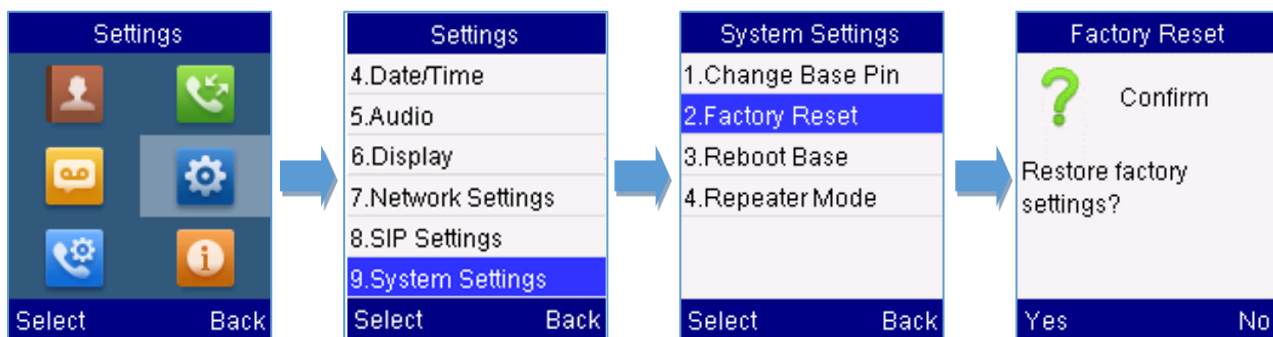

Figure 36: Resetting the Base Station



## CALL OPERATIONS

This chapter will guide you to place calls, transferring and holding the incoming calls.

### Placing calls

To place calls, you can use the following mode:

- **Earpiece mode:** pressing the off-hook key to dial out.
- **Speakerphone mode:** pressing the speakerphone key to dial out.
- **Headset mode:** pressing the off-hook key to dial out using connected headset.



During the call, you can switch the call mode by pressing the corresponding keys or connecting a headset.

### Make a Call using a Line



Making calls require the use of SIP lines. So, you should first register the SIP account to the handset beforehand, after registering the sip lines, you can assign one or more outgoing lines for the handset. The handset can only use the assigned outgoing line(s) to place calls.

**Please refer to the following methods to make calls using a line:**



#### Method 1:

- **Via default outgoing line:**
  1. Enter the desired number using the keypad.
  2. Press **Dial key**  or **Speaker key**  . The handset will use the default outgoing line to dial out.
  3. To terminate the call, press **Hang-Up key**  .



**Note:** To change the default outgoing line, please refer to [Outgoing Default line](#).

- **Selecting the outgoing line:**
  1. Enter the desired number using the keypad.
  2. Press the left softkey  "Call".
  3. Select the desired line to dial out.
  4. To terminate the call, press **Hang-Up key**  .

#### Method 2:

1. Press **Dial key**  or **Speaker key**  to enter the pre-dialing screen.
2. Enter the number to dial using the keypad.



3. Press **Dial key**  , # (Use # as dial key” must be configured in web configuration) or wait for 4 seconds and the call will be initiated automatically.
4. To terminate the call, press **Hang-Up key**  .





During the call, you can switch the call mode by pressing the corresponding keys and cancel the dialing operation by pressing the on-hook key. During the call conversations, you can press the left and right navigation keys to adjust the volume. The call duration is displayed on the LCD screen while the call is in progress and call summary will be displayed once the call is terminated.

**Notes:** - To dial “+” please keep pressing “0” key for about 2 seconds.

- To dial from contacts list, choose a contact using navigation keys and press **Dial key** .

### Dialing from Call history

Users may use their call history entries to initiate calls.



1. Press **Menu** (left softkey  or the selection key  ) to bring up operation menu.
2. Use arrow keys to reach **Call History** Icon  and then press “Select” (left softkey  ).
3. Select the desired entry, then press **Dial key**  to establish the call.

**Note:** In step 3, users can press “Options” softkey followed by “Edit Dial” option to initiate the call.

The call history list stores the last dialed phone numbers. When the memory of the redial number list is full, the handset will automatically erase the oldest dialed number when a new number is dialed

### Dialing from Phonebook

Users may use their private or shared contacts to initiate calls.

1. Press **Contacts** (right softkey  ) to access phonebook menu.
2. Select **Private** or **Shared** phonebook.
3. Select the contact to call.
4. Press **Dial Key**  to initiate the call.





**Note:** In step 3, users can press “Options” softkey followed by “Edit Dial” option to initiate the call.







## Answering Calls

When receiving an incoming call, you can answer the call using following steps:

- **Earpiece mode:**  
Press **Dial Key**  to pick up the call, or “Accept” softkey (left softkey  ).
- **Speakerphone mode:**  
Press **Speaker Key**  to pick up the call.
- **Headset mode:**  
Press **Dial Key**  to pick up the call, or “Accept” softkey (left softkey  ) using a connected headset.

### Note:



- To answer an incoming call during an established call, press **Dial Key**  , or the **Speaker Key**  , or the “Answer” softkey. The incoming call is answered, and the original call is placed on hold.
- You can switch off the ringer temporarily by pressing **Silent** softkey.

## Auto Answer

Users can enable Auto Answer feature to accept and automatically answer incoming calls.

If enabled, DP720 Handset will automatically answer incoming calls using speaker mode.

To activate / deactivate the auto answer feature:

- **Using DP720 Handset Menu**
  1. Press **Menu** (left softkey  or the selection key  ) to bring up operation menu.
  2. Use arrow keys to reach **Settings**  → **User Settings** and navigate to **Auto Answer** using the up/down arrow keys.
  3. Switch between Enabled/Disabled using left/right arrow keys and “Save” after **Enabling / Disabling** the option.
- **Using DP750 Base Station Web Interface**
  1. Access DP750 Base Station Web Interface.
  2. Go to DECT → Handset Settings → HS# Settings.
  3. Set “Enable Auto Answer” to “Yes”. (By default, set to “No”).



## Off-Cradle Pickup



Users can enable Off-Cradle Pickup feature to automatically answer incoming calls after picking up DP720 Handset from its cradle. Incoming calls will be automatically answered using earpiece mode.

### Notes:

- DP720 Handset should be resting on its cradling and then picked up for this feature to work.
- “Auto Answer” feature should be set to “No” to work properly.

To activate / deactivate the off-cradle pickup:

#### • Using DP720 Handset Menu

1. Press **Menu** (left softkey  or the selection key  ) to bring up operation menu.
2. Use arrow keys to reach **Settings**  → **User Settings** and navigate to **Off-Cradle Pickup** using the up/down arrow keys.
3. Switch between Enabled/Disabled using left/right arrow keys and “Save” after **Enabling / Disabling** the option.

#### • Using DP750 Base Station Web Interface

1. Access DP750 Base Station Web Interface.
2. Go to DECT → Handset Settings → HS# Settings.
3. Set “Enable Onhook on Cradle Reposition” to “Yes”. (By default, set to “No”).

## Ending Calls

To terminate the calls, press **Hang-Up key** .

## On-Cradle Hang-up

Users can enable On-Cradle Hang-up feature to automatically end ongoing calls after placing DP720 Handset on its cradle.

To activate / deactivate the on-cradle hang-up feature:

#### • Using DP720 Handset Menu

1. Press **Menu** (left softkey  or the selection key  ) to bring up operation menu.



2. Use arrow keys to reach **Settings**  → **User Settings**, and navigate to **On-Cradle Hang-up** using the up/down arrow keys.
  3. Switch between Enabled/Disabled using left/right arrow keys and “Save” after **Enabling / Disabling** the option.
- **Using DP750 Base Station Web Interface**
    1. Access DP750 Base Station Web Interface.
    2. Go to DECT → Handset Settings → HS# Settings.
    3. Set “Enable Off hook on Cradle Pickup” to “Yes”. (By default, set to “No”).

## Rejecting Calls

To reject an incoming call, press **Hang-Up key**  or “Reject” softkey (right softkey  )

## Direct IP Call

Direct IP calling allows two parties, that is, a handset and another VoIP device, to talk to each other in an ad hoc fashion without a SIP proxy.

### Elements necessary to complete a Direct IP Call:

- Both DP720 and other VoIP Device, have public IP addresses, or
- Both DP720 and other VoIP Device are on the same LAN using private IP addresses, or
- Both DP720 and other VoIP Device can be connected through a router using public or private IP addresses (with necessary port forwarding or DMZ).

Users can perform IP calls using Star code following the below steps:

1. Pick up the handset and press **Dial key**  .
2. Dial **\*47** followed by the target IP Address.

**Note:** You can enter directly \*47 + target IP address, and then press the dial key to initiate the call.

### Examples of direct IP calls

- a) If the target IP address is 192.168.0.160, the dialing convention is **\*47 then 192\*168\*0\*160**, followed by pressing the “#” key if it is configured as a send key or wait 4 seconds. In this case, the default destination port 5060 is used if no port is specified.







- b) If the target IP address/port is 192.168.1.20:5062, then the dialing convention would be:  
**\*47 or Voice Prompt with option 47, then 192\*168\*0\*160\*5062** followed by pressing the “#” key if it is configured as a send key or wait for 4 seconds.

**Note:** To accept incoming direct IP call, **Use Random Port** setting should be set to **NO**. If set to **YES**, it can only dial out. The setting is available on DP750 web interface → Profile → SIP Settings → Basic Settings.

## Call Hold/Resume

During an established call, you can put the call on hold and resume following below steps:

1. Press the left softkey  to access the call **Options** and then navigate to **Hold**.
2. Press “Select”, left softkey  to put the call on hold.
3. To resume the call, access the options menu again and navigate to **Resume**, then press **Select**.





If you press  during the call, the first call will be on hold, and you can establish a new call; to resume the initial call, press .

## Call Waiting



This feature will notify you of a new incoming call during an established call, and display the incoming call information visually on the LCD screen and a call waiting tone will be heard. If this feature is disabled, the new incoming call will be automatically rejected.

There are 2 ways to activate call waiting feature either using DP720 Handset Menu or using DP750 Base Station Web Interface.

- **Using DP720 Handset Menu**

1. Press **Menu** (left softkey  or the selection key  ) to bring up operation menu.
2. Access to **Call settings**  and then to **Call waiting** sub-menu.
3. Select the account for which you want to enable the Call waiting feature, and then press left softkey “Select” .
4. Choose between **Enabled** and **Disabled** options and press the softkey “Save”, a prompt message will be displayed to confirm that the call waiting is enabled / disabled.



5. During an established call, press  (dial key) to put first call on hold and answers second incoming call. If no second incoming call, pressing  will give the ability to initiate another call while first one is on hold.

**Note:** You can switch between active/on-hold calls by pressing **Options → Swap**.



- **Using DP750 Base Station Web Interface**

1. Access DP750 Base Station Web Interface.
2. Go to DECT → Handset Settings → HS# Settings.
3. Set “Disable Call Waiting Tone” to “No”. (Default is No).
4. Press “Save and Apply” button to confirm.

## Do Not Disturb

You can activate or deactivate the DND mode for your accounts registered on the handset under the call settings. If DND mode is activated for a specific line, all incoming calls will receive busy treatment depending on your configuration (forward to voice mail, busy tone...)

### To enable or disable the DND mode, follow the next steps

1. Press **Menu** (left softkey  or the selection key  ) to bring up operation menu.
2. Access **Call settings**  and then to **Do Not Disturb** sub-menu.
3. Select the account on which you want to enable / disable the DND mode and then press “Select”
4. Choose between **Enabled** and **Disabled** options and press softkey “Save” to accept the changes, a prompt message will be displayed to confirm that the DND is enabled / disabled.

You can check the line status if the DND mode is enabled on the base station.





## Call Forward

The call forward feature will allow you to forward all the incoming calls to the desired number. Three possible call forward types are available on the DP720.

- **Forward all:** All the incoming calls are immediately forwarded.
- **Busy Forward:** Incoming calls are immediately forwarded if the line is busy.
- **No Answer Forward:** Incoming calls are forwarded if not answered after a period of time.



To enable the call forward, please refer to the following steps:



1. Press **Menu** (left softkey  or the selection key  ) to bring up operation menu.
2. Access to **Call settings**  and then to **Call Forward** sub-menu.
3. Select the account on which you want to enable/disable the call forward feature and press “Select”.
4. Select the type of call forwarding and enter the number to forward the calls, and then press “Save” (left softkey  ) to apply the settings, a prompt message will be displayed to confirm that the new settings have been saved successfully.

## Call Transfer



The DP720 supports the call transfer feature, you can transfer a call to another party using one of the following ways:

- **Blind transfer:** Transfer a call directly to another party without consulting
- **Attended transfer:** Transfer a call with prior consulting.

### Blind Transfer

1. Press the “Options” softkey (Left softkey  ) during a call, and then select **Transfer**.
2. The initial call will be on hold, enter the number you want to transfer the call to.
3. Press **Dial key**  . The call is connected to the number or the handset you specified, and the LCD screen prompts **Call Transferred**.

### Attended Transfer

1. Press Left softkey “Options”  during a call, and then select **New call**.
2. Choose the line and enter the number you want to transfer the call to, then press **Dial key**  .
3. Once the second call is established, press left softkey “Option”  and select **Transfer**.



## Speed Dial

Speed dial allows users to perform single-digit dialing to predefined numbers. This feature is particularly useful to speed up dialing frequently used or hard to remember numbers. A maximum of 8 speed dial numbers is allowed. Allowed

For example, the digit key 2 is configured as a speed dial key and assigned the number 2000, the phone will dial out the number 2000 directly when you long press digit key 2.



❑ **To assign the frequently used numbers as speed dial keys:**

1. Press **Menu** (left softkey  or the selection key ) to bring up operation menu. And access to **Call settings**  and then to **Speed Dial** sub-menu.

Or;

Long press the representative number from 2 to 9 to set. (Note: The Speed dial number should not be set on chosen representative number, otherwise long press will initiate a call to configured speed dial number).

2. Choose the digit key (2-9) to set and press **Options** or **OK** button. Three options will be available:
  - **Edit:** To configure manually a contact as speed dial. Users need to enter “First Name”, “Last Name” and “Number”. (Note: First Name + Number or Last Name + Number are accepted).
  - **From Contacts [P]:** To set a contact from the private directory to be as speed dial.
  - **From Contacts [S]:** To set a contact from the shared directory to be as speed dial

❑ **To Modify a Speed Dial:**

Repeat above 2 steps.

At step 2, re-edit /re-assign a contact from the shared or private directory as speed dial on selected key.

❑ **To Delete a Speed Dial:**



Repeat above 2 steps.

At step 2, select **Clear Entry** option and press **OK** or **Select** to confirm.

## 3-Way Conference

The DP720 supports creating a local conference with other parties (including handset starting the conference).

**To start a 3 Way conference, follow below steps:**

1. Press the **Dial key**  to place a call to the first party.
2. Press left softkey “Options” , then select **Conference**
3. Enter the number of the second party you want to add to the conference and press **Dial Key** .

To drop the conference call, press  or “End” softkey.

**Note:** Conference can be bridged before third party answers.



## Voice Mail



The voice mail feature ensures that you will never miss any important messages. It permits either to leave voice mails to someone else or receive and listen to voice mails via the handset

### Set Voice Mail Feature Code

There are 2 ways to set Voice Mail Feature Code, either using DP720 Handset Menu or using DP750 Base Station Web Interface.

Note: The Voice Mail Feature Code depends on the service provider or IP-PBX used. For example, if UCM6xxx as SIP server, the Voice Mail Feature Code is \*97.



- **Using DP720 Handset Menu**

1. Press **Menu** (left softkey  or the selection key  ) to bring up operation menu.
2. Access to **Voice Mail**  and then select **Set Voice Mail** sub menu.
3. Select the account and enter the voice mail code feature, then press “Save” softkey.

- **Using DP750 Base Station Web Interface**

1. Access DP750 Base Station Web Interface.
2. Go to Profiles → Profile X → General Settings.
3. Configure **Voice Mail Access Number**.

### Play Voice Mail Messages

1. Press “Menu” (left softkey  or the selection key  ) to bring up operation menu.
2. Access to **Voice Mail**  and then select **Play Message** sub menu.
3. Select the account to retrieve your voice messages saved on your voice mail.

Or;

Long press digit “1” key to dial configured Voice Mail feature code using Default Line.

#### Notes:

- Users can access directly voicemail menu to play messages, by clicking on “View” (left softkey ) when the notification of a new voicemail pops up on the DP720’s LCD screen.
- If VM is protected by a password, users can enter the password using DP720 keypad after reaching Voice Mail system. The password is defined on the service provider or IP-PBX side.





## Call Features

The DP750/DP720 supports traditional and advanced telephony features including call forward and etc.

**Table 10: Call Features**

<b>*72</b>	<p><b>Unconditional Call Forward.</b> To set up unconditional call forward:</p> <ul style="list-style-type: none"> <li>• Off hook the phone;</li> <li>• Dial *72 and then enter the number to forward the call;</li> <li>• Press OK softkey or SEND key.</li> </ul>
<b>*73</b>	<p><b>Cancel Unconditional Call Forward.</b> To cancel the unconditional call forward:</p> <ul style="list-style-type: none"> <li>• Off hook the phone;</li> <li>• Dial *73;</li> <li>• Hang up the call.</li> </ul>
<b>*90</b>	<p><b>Busy Call Forward.</b> To set up busy call forward:</p> <ul style="list-style-type: none"> <li>• Off hook the phone;</li> <li>• Dial *90 and then enter the number to forward the call;</li> <li>• Press OK softkey or SEND key.</li> </ul>
<b>*91</b>	<p><b>Cancel Busy Call Forward.</b> To cancel the busy call forward:</p> <ul style="list-style-type: none"> <li>• Off hook the phone;</li> <li>• Dial *91;</li> <li>• Hang up the call.</li> </ul>
<b>*92</b>	<p><b>Delayed Call Forward.</b> To set up delayed call forward:</p> <ul style="list-style-type: none"> <li>• Off hook the phone;</li> <li>• Dial *92 and then enter the number to forward the call;</li> <li>• Press OK softkey or SEND key.</li> </ul>
<b>*93</b>	<p><b>Cancel Delayed Call Forward.</b> To cancel the delayed call forward:</p> <ul style="list-style-type: none"> <li>• Off hook the phone;</li> <li>• Dial *93;</li> <li>• Hang up the call.</li> </ul>



## RESTORE FACTORY DEFAULT SETTINGS

---

 **Warning:**

Restoring the factory default settings will delete all configuration information on the phone. Please backup or print all the settings before you restore to the factory default settings. Grandstream is not responsible for restoring lost parameters and cannot connect your device to your VoIP service provider.

---

Please follow the instructions below to reset the phone:

1. Press **MENU** button to bring up the keypad configuration menu;
2. Select **Settings** and enter;
3. Select **System Settings → Factory Reset**;
4. A warning window will pop out to make sure a reset is requested and confirmed;
5. Press **Yes** softkey to confirm and the phone will reboot.
6. To cancel the Reset, press **No** softkey instead.

Users also can perform factory reset using combo keys on DP720 during booting up prior it's fully booted, to give DP720 the ability to recover from some extreme cases like self-reboot or stuck right after booted up.

Please refer to following procedure for DP720 factory reset using combo key:

1. Connect the USB cable and power off DP720.
2. Power on DP720 and wait for Green LED.
3. Press 3 times Central Key (OK/Selection Key) quickly after Green LED on.
4. Press Speaker Key (left bottom) first and then Mute Key (right bottom) after Red LED on.
5. DP720 LED will start blinking in 3 colors: Green, Red and Orange if factory reset successful triggered.
6. Wait for about 1-3 minutes, the DP720 will boot up with setup wizard for initial language and date format settings.



## EXPERIENCING DP750/DP720

Please visit our website: <http://www.grandstream.com> to receive the most up- to-date updates on firmware releases, additional features, FAQs, documentation and news on new products.

We encourage you to browse our [product related documentation](#), [FAQs](#) and [User and Developer Forum](#) for answers to your general questions. If you have purchased our products through a Grandstream Certified Partner or Reseller, please contact them directly for immediate support.

Our technical support staff is trained and ready to answer all your questions. Contact a technical support member or [submit a trouble ticket online](#) to receive in-depth support.

Thank you again for purchasing the Grandstream DP720 / DP750, it will be sure to bring convenience and color to both your business and personal life.

